

Kwikee Service Training Manual

Wednesday, November 14, 2018 7:09 PM

WELCOME to the Kwikkee Products Service Training.

It is our sincere hope that the information you gain from this training will enhance your confidence in and familiarity with the products we manufacture. The information will give you overviews of the products and some details on installation, maintenance, and repair.

From time to time, changes occur in procedures, specifications, and even the products themselves. As with any product information, keeping the latest information at your disposal is an ongoing and integral part of providing you with a quality product. Every product we ship includes the most current documentation and RV manufacturers provide binders or files for owners to store Kwikkee and other product documentation in the RV. But we know that doesn't always happen. We know, too, that RVs get serviced, parts get changed, and changes aren't reflected or noted in the original documentation. If, however, there is documentation, we encourage you to look it over before servicing the equipment, even if you are fairly familiar with the product.

KEEPING SERVICE INFORMATION CURRENT

You may want to regularly check our website (www.kwikkee.com) and look at the downloadable documentation section. Here you will find the most recent versions of all of our documentation. You can view these documents online or print them out to keep your binder up-to-date.

We are also available to help you by phone:
Kwikkee Customer Service Department
1-800-736-9961
 Weekdays 7:00 am to 4:00 pm (PST)

KWIKTIP

On the front page of every Kwikkee document is a literature number and the date the document was developed or revised. You can make sure you are looking at the most recent documentation by comparing your document with the documents on Kwikkee's website at www.kwikkee.com



3/04 Kwikkee Products
 #1422259

STEPS

Currently Kwikkee makes 19 different styles of electric steps; 10 with single treads; 5 with double treads; and 4 with triple treads. Each style is identified by a 'Series' number.

Single Tread Step Series

Series 26

Rise: 5" Run: 8.5"
Bolt pattern: 7.5" x 20.5"

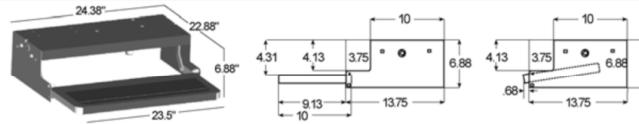

Series 28

Rise: 7" Run: 10"
Bolt pattern: 6.5" x 22"

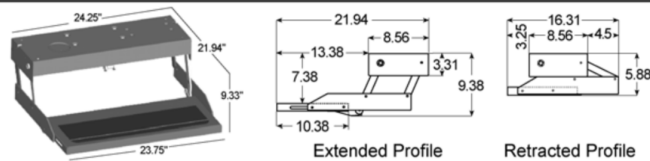

Series 30

Rise: 7.5" Run: 16.75"
Bolt pattern: 6" x 31"

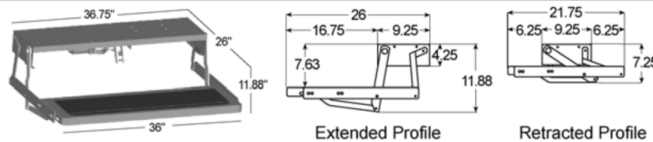

Series 31

Rise: 7" Run: 10.5"
Bolt pattern: 7.4" x 14.5"

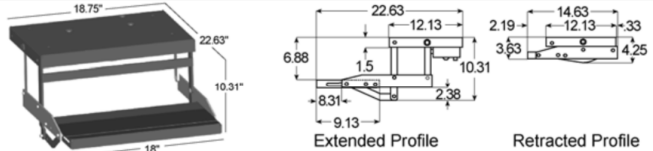

Series 33

Rise: 8" Run: 16.75"
Bolt pattern: 6" x 23.5"

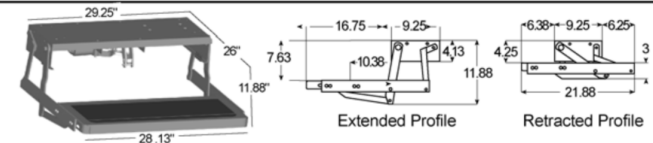

Series 35

Rise: 5" Run: 10.75"
Bolt pattern: 8" x 22"

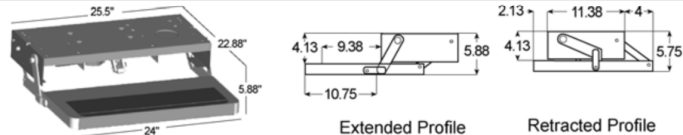

Series 36

Rise: 5" Run: 10.75"
Bolt pattern: 8" x 26"

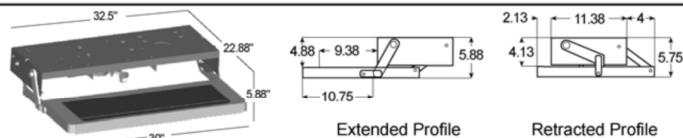

Series 37

Rise: 7" Run: 8.5"
Bolt pattern: Call

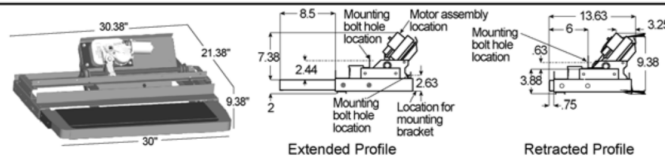

STEPS

To determine which step you have, look for a sticker on the underside of the top tread or mouting surface. If you can't locate it, measure the step and use these drawings to identify the step.

<p>Series 38</p>	<p>Rise: 4" Run: 10.75" Bolt pattern: 8" x 22"</p>				
<p>Series 39</p>	<p>Rise: 7" Run: 10" Bolt pattern: 7.5" x 20.5"</p>				
<p>Double Tread Step Series</p>					
<p>Series 22</p>	<p>Rise: 8" Run: 8" Bolt pattern: 9" x 25.5"</p>				
<p>Series 32</p>	<p>Rise: 7" Run: 9" Bolt pattern: 8" x 22"</p>				
<p>Series 34</p>	<p>Rise: 7" Run: 9" Bolt pattern: 8" x 26"</p>				
<p>Series 40</p>	<p>Rise: 8" Run: 9" Bolt pattern: 8" x 26"</p>				
<p>Series 42</p>	<p>Rise: 6" Run: 9" Bolt pattern: 18" x 29"</p>				

STEPS

Currently Kwikee makes 19 different styles of electric steps; 10 with single treads; 5 with double treads; and 4 with triple treads. Each style is identified by a 'Series' number.

Triple Tread Step Series**Series 23**

Rise: 8" Run: 8"
Bolt pattern: 9" x 25.25"

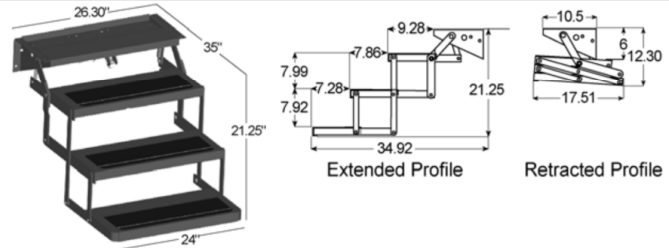
**Series 24**

Rise: 8" Run: 9"
Bolt pattern: 8" x 26"

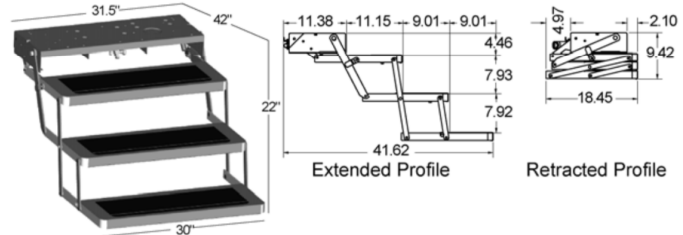
**Series 25
7" Drop**

Rise: 7" Run: 8"
Bolt pattern: 8" x 22"

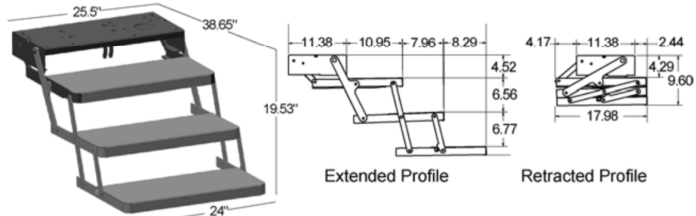
**Series 25
8" Drop**

Rise: 8" Run: 9"
Bolt pattern: 8" x 22"

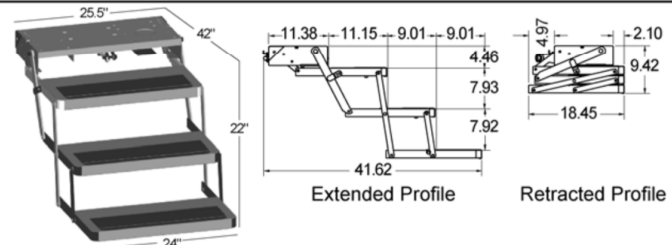
**Series 44**

Rise: 8" Run: 9"
Bolt pattern: 8" x 22"

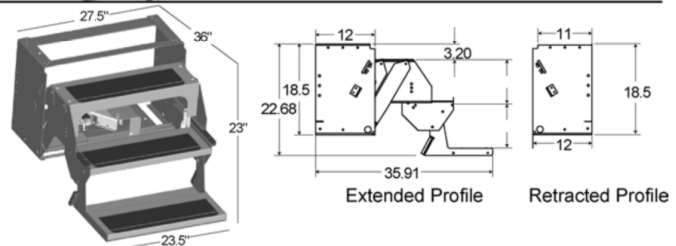

STEPS IMPROVEMENTS

In October of 2004, Kwikkee began shipping steps with an integrated motor/gear box/linkage (IMGL). Steps with the IMGL require a 909510000 Control Unit. This section of the Service Training will cover repairs to steps that have the IMGL/9510 configuration. Steps shipped prior to October of 2004 may have a variety of motor/control unit configuration.

Any steps (except the 42 and 44 Series), regardless of the original motor/control unit combination, can be repaired using the current IMGL/9510 parts and procedures. If you are needing to repair a 42 or 44 Series, please call our Customer Service Department at 1-800-736-9961.

Please note, if you are replacing the IMGL on a step that has any control other than a 909510000 Control Unit, you must also change the control unit. **Previous Control Units will not work correctly with the IMGL and the 9051 Control Unit will not work correctly with previous motor/gear box/linkage configurations.**

There are three IMGLs; one with each of the three linkages for Kwikkee steps.

'A' LINKAGE IMGL fits 22, 23, 30, 32, 33, 34, 35, 36, 38, and 40 Series Steps.

'B' LINKAGE IMGL fits 28, 31, 37, and 39 Series Steps.

'C' LINKAGE IMGL fits 26 Series Steps.

Kwikkee manufactures a complete Replacement Kit for each of the three linkages. These kits include the IMGL (integrated motor/gear box/linkage,) the 9510 Control Unit, a four-way pigtail, a fastener kit, and installation documentation.

Repair Kit Part #	Linkage	Fits Step Series
909770000	'A' LINKAGE IMGL	22, 23, 30, 32, 33, 34, 35, 36, 38, 40
909772000	'B' LINKAGE IMGL	28, 31, 37, 39
909774000	'C' LINKAGE IMGL	26

CONTROL UNIT REPLACEMENT

For steps that already have the IMGL/909510000 Control, the 909510000 Control Unit can be replaced with the same part number but steps with any other Control Unit require a full replacement kit as listed above. The 909510000 Control Unit will not work correctly with any motor, gearbox configurations other than the IMGL.

IMGL (integrated motor/gear box/linkage)

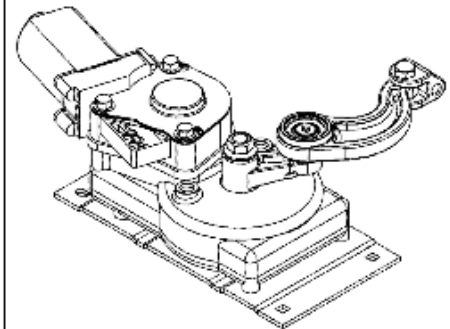

909510000 Control Unit

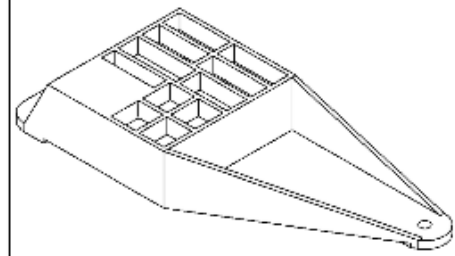

INCREASED PERFORMANCE, RELIABILITY

NO MORE SPONGEY STEPS

The new IMGL (integrated motor/gear box/linkage) and control unit configuration provides a 40% 'stiffer' step. Steps feel stronger, run longer.

**PRODUCT IMPROVEMENT BULLETIN**

www.kwikkee.com Kwikkee Products Company, Inc. 230 Davidson Avenue Cottage Grove, Oregon 97424-9545

Electric Step Improvements

Applies to Kwikkee Step Series 22, 23, 26, 28, 30, 31, 32, 33, 34, 35, 36, 37, 38, 39, and 40

Kwikkee announces the replacement of specific parts on Kwikkee Electric Steps with improved components. New parts include:

- Linkage and Gear Box
- Motor, and
- Control Unit

on Kwikkee Electric Step Series 22, 23, 26, 28, 30, 31, 32, 33, 34, 35, 36, 37, 38, 39, and 40.

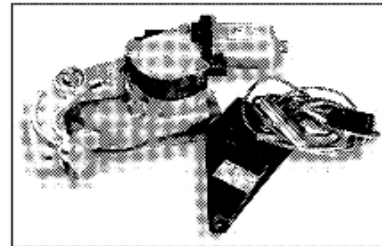

The step improvements were made to increase performance, reliability, and longevity of step operation. The changes also simplify parts replacement procedures.

Improved linkage and gear box Investment cast zinc plated steel linkage assembly is strong and more resistant to corrosion. Brass spherical outer cage hardened ball in linkage is stronger, wears longer, and will not oblong. Improved gear box has fully sealed dual ball bearing for greater efficiency and no maintenance. Case halves seal for consistent alignment and gear protection from the elements.

Improved motor 40% more motor torque gives step a strong lock-out and solid feel.

Improved control unit logic Step is always open when door is open. Step can be locked in the extended position. Step cannot be locked in retracted position. Automatic ignition override makes step follow the door.

New Owners Manual A new #888 Owners Manual ships with all steps that have the improved step components.

An important change covered in the #888 Owners Manual is the "Override Switch" (previously call the "Power Switch" in Kwikkee #880 manuals.) The name of the switch changed because of a change in functionality from the former "Power Switch."

The new Control Units are equipped with an ignition override system designed to prevent the vehicle from being driven with the step in the extended position. When the step is locked in the extended position (OVERRIDE SWITCH IS IN THE 'ON' POSITION), the door is closed, and the ignitor is turned on, the ignition override system will engage and the step will automatically retract.

Please note that this is a change from the old "Power Switch," which needed to be in the "OFF" position to lock the step out.

If you have questions, contact your Kwikkee salesperson or call the Kwikkee Service Department at 1-800-736-9961.

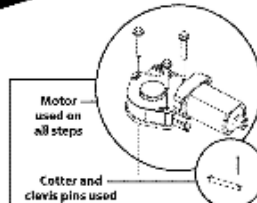

'A' Linkage used on Step Series 22, 23, 30, 32, 33, 34, 35, 36, 38, and 40

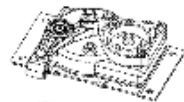

'B' Linkage used on Step Series 28, 31, 37, 39



'C' Linkage used on Step Series 26

IMGL Step Assembly © Kwikkee 1204

KWIKTIP: CONTROL UNIT LOGIC

With the new IMGL and Control Unit logic:

WHEN THE **OVERRIDE SWITCH IS 'ON'**
THE STEP IS **LOCKED** IN THE
EXTENDED POSITION

IF THE **IGNITION**
IS TURNED **'ON'**

(WHETHER THE
OVERRIDE SWITCH
IS 'ON' OR 'OFF')

THE STEP WILL FOLLOW THE DOOR

Door Open = Step Extended

Door Closed = Step Retracted

KWIKTIP: LOOK FOR THE STICKERS

The new IMGL and Control Unit can easily be identified by the following stickers:



'214' on the printed sticker identifies an IMGL (integrated motor/gear box/linkage)



909510000 printed on the control sticker identifies a 909510000 Control Unit



22 SERIES Step Replacement Guide

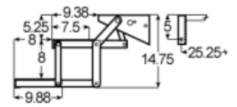
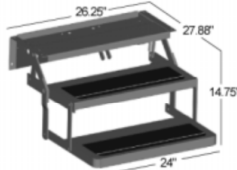

Extended Profile

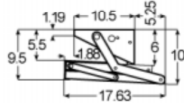

Retracted Profile

STEP SERIES NUMBER

To determine correct replacement part numbers, it is necessary to know the **Step Series Number**. It is located in the Owners Manual and printed under the top step.

If you can not locate the number, measure the step and refer to the dimensioned drawings above. Confirm that you are using the correct step series replacement parts guide.

RISE: 8" RUN: 8"
Mounting bolt pattern: 9 x 25.25"

Part #902200016
24" tread with Motor and Switch Kit (#905316000)

Part #902206025
24" tread with Motor, Control Unit and Switch Kit (#905325000)

Motor Assembly Drawing and Parts Key Numbers

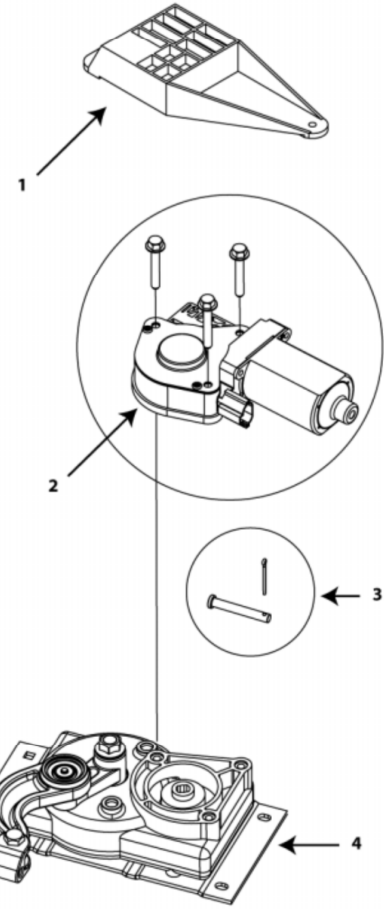

CHART 1 Replacement Parts Kits for Series Steps 22, 23, 30, 32, 33, 34, 35, 36, 38, and 40		
Parts Key #	Description	Replacement Kit Part #
1	Control Unit only	
n/a	Step Frame only	908022000
n/a	Step Light only	909004000
3	Cotter and Clevis pin	
1-4	IMGL 'A'/Control Replacement Kit <small>909510000 Control, IMGL Integrated Motor, Gear Box, Linkage A), Cotter and Clevis pin, Four-way pigtail, Fasteners</small>	909770000

Door Switches		
Part # White* (Closed)	Part # Black** (Open)	Description
905312000	905323000	Magnetic, small rectangular
905314000	905324000	Magnetic, 3/4" core round
905306000	905326000	Magnetic, large rectangular
905307000	905327000	Magnetic, 3/8" core round
905302000	905328000	Plated plunger switch

* Used for all color controls manufactured prior to 2/99. Does NOT include "black" 909506000, 909507000.
** Used for "black" controls since 2/99 including 909506000, 909507000, and 909508000.

Rocker Style Power Switch	
Part #	Description
905305000	For all fully automatic steps.

Self-Center Rocker Switch	
Part #	Description
905316000	For steps NOT equipped with control units.



23 SERIES

Step Replacement Guide

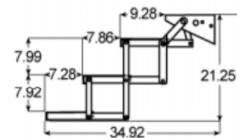

Extended Profile

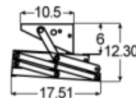

Retracted Profile

STEP SERIES NUMBER

To determine correct replacement part numbers, it is necessary to know the **Step Series Number**. It is located in the Owners Manual and printed under the top step.

If you can not locate the number, measure the step and refer to the dimensioned drawings above. Confirm that you are using the correct step series replacement parts guide.

RISE: 8" RUN: 8"
Mounting bolt pattern: 9 x 25.25"

Part #902300016
24" tread with High-torque Motor and Switch Kit (#905316000)

Part #902308025
24" tread with High-torque Motor, Control Unit and Switch Kit (#905325000)

Motor Assembly Drawing and Parts Key Numbers

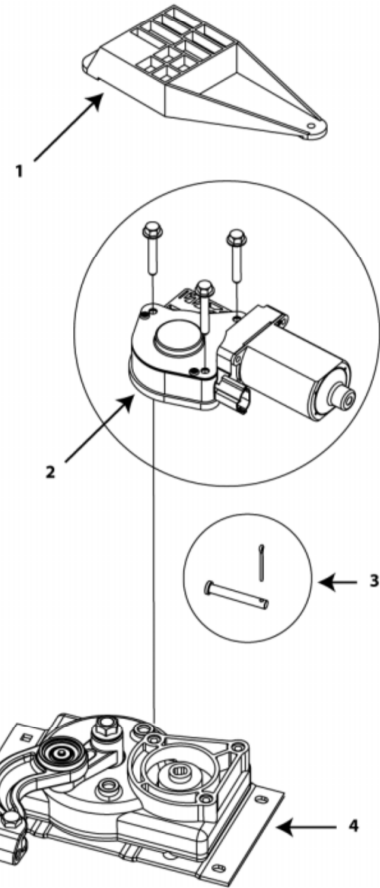

CHART 1 Replacement Parts Kits for Series Steps 22, 23, 30, 32, 33, 34, 35, 36, 38, and 40		
Parts Key #	Description	Replacement Kit Part #
1	Control Unit only	
n/a	Step Frame only	908023000
n/a	Step Light only	909004000
3	Cotter and Clevis pin	
1-4	IMGL 'A'/Control Replacement Kit 909510000 Control, IMGL (Integrated Motor, Gear Box, Linkage A), Cotter and Clevis pin, Four-way pigtail, Fasteners	909770000

Door Switches		
Part # White* (Closed)	Part # Black** (Open)	Description
905312000	905323000	Magnetic, small rectangular
905314000	905324000	Magnetic, 3/4" core round
905306000	905326000	Magnetic, large rectangular
905307000	905327000	Magnetic, 3/8" core round
905302000	905328000	Plated plunger switch

* Used for all color controls manufactured prior to 2/99. Does NOT include "black" 909506000, 909507000.
 ** Used for "black" controls since 2/99 including 909506000, 909507000, and 909508000.

Rocker Style Power Switch	
Part #	Description
905305000	For all fully automatic steps.

Self-Center Rocker Switch	
Part #	Description
905316000	For steps NOT equipped with control units.

This image shows a large rectangular area designed for writing. It features a vertical red margin line on the left side and horizontal blue lines for the main body of the page. The lines are evenly spaced and cover the entire width of the page within the red margin.

This image shows a large rectangular area designed for writing. It features a vertical red margin line on the left side and horizontal blue lines for the main body of the page. The lines are evenly spaced and cover the entire width of the page within the red margin.

A large rectangular area with a red vertical margin line on the left and light blue horizontal ruling lines, resembling a page for writing or notes.

This image shows a large rectangular area designed for writing. It features a vertical red margin line on the left side and horizontal blue lines for the main body of the page. The lines are evenly spaced and cover the entire width of the page within the red margin.



32 SERIES Step Replacement Guide

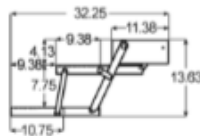
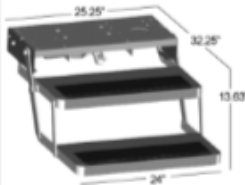

Extended Profile

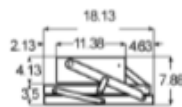

Retracted Profile

STEP SERIES NUMBER

To determine correct replacement part numbers, it is necessary to know the **Step Series Number**. It is located in the Owners Manual and printed under the top step.

If you can not locate the number, measure the step and refer to the dimensioned drawings above. Confirm that you are using the correct step series replacement parts guide.

RISE: 7" RUN: 9"
Mounting bolt pattern: 8 x 22"

Part #903200016
24" tread with Motor and Switch Kit (#905316000)

Part #903206025
24" tread with Motor, Control Unit and Switch Kit (#905325000)

Motor Assembly Drawing and Parts Key Numbers

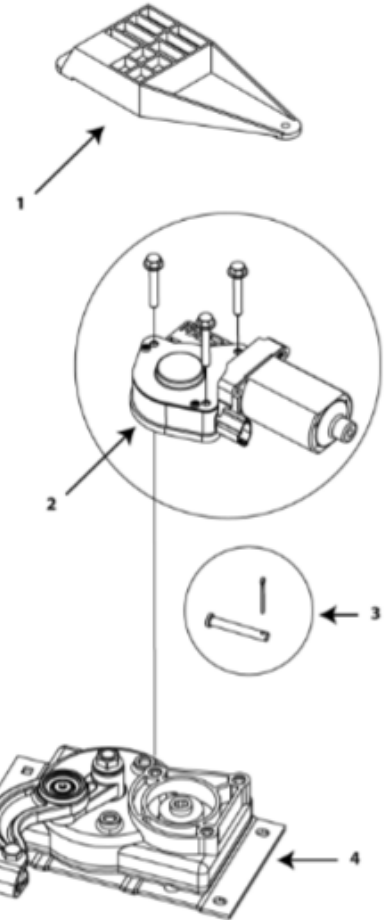

CHART 1 Replacement Parts Kits for Series Steps 22, 23, 30, 32, 33, 34, 35, 36, 38, and 40		
Parts Key #	Description	Replacement Kit Part #
1	Control Unit only	
n/a	Step Frame only	908032000
n/a	Step Light only	909004000
3	Cotter and Clevis pin	
1-4	IMGL 'A' Control Replacement Kit 909510000 Control, IMGE (Integrated Motor, Gear Box, Linkage A), Cotter and Clevis pins, Four-way pigtail, Fasteners	909770000

Door Switches		
Part # White* (Closed)	Part # Black** (Open)	Description
905312000	905323000	Magnetic, small rectangular
905314000	905324000	Magnetic, 3/4" core round
905306000	905326000	Magnetic, large rectangular
905307000	905327000	Magnetic, 3/8" core round
905302000	905328000	Plated plunger switch

* Used for all color controls manufactured prior to 2/99. Does NOT include "black" 909506000, 909507000.
** Used for "black" controls since 2/99 including 909506000, 909507000, and 909508000.

Rocker Style Power Switch	
Part #	Description
905305000	For all fully automatic steps.

Self-Center Rocker Switch	
Part #	Description
905316000	For steps NOT equipped with control units.



33 SERIES

Step Replacement Guide

Available with brackets for Van applications

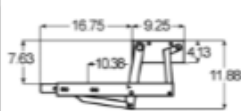
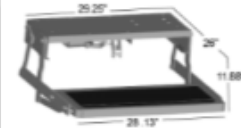

Extended Profile

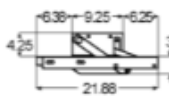

Retracted Profile

STEP SERIES NUMBER

To determine correct replacement part numbers, it is necessary to know the **Step Series Number**. It is located in the Owners Manual and printed under the top step.

If you can not locate the number, measure the step and refer to the dimensioned drawings above. Confirm that you are using the correct step series replacement parts guide.

RISE: 8" RUN: 16.75"
Mounting bolt pattern: 6.5 x 22"

RV: Part #903300016
28.13" tread with Motor and Switch Kit (#905316000)

RV: Part #903306025
28.13" tread with Motor, Control Unit and Switch Kit (#905325000)

VANS: Part #903300000
28.13" tread with Motor and no Control Unit

VANS: Part #903306000
28.13" tread with Motor and Control Unit

VANS: Part #909315000
Plastic Splash Cover for 30 and 33 Series Steps

Motor Assembly Drawing and Parts Key Numbers

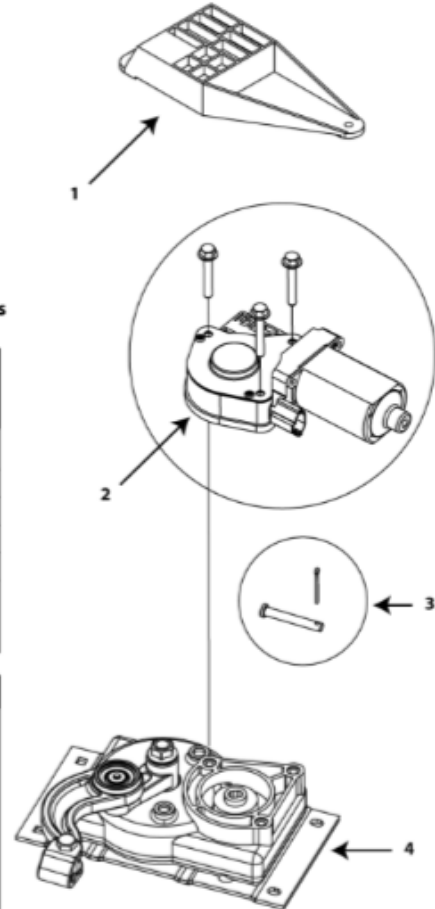

CHART 1 Replacement Parts Kits for Series Steps 22, 23, 30, 32, 33, 34, 35, 36, 38, and 40		
Parts Key #	Description	Replacement Kit Part #
1	Control Unit only	
n/a	Step Frame only	908033000
n/a	Step Light only	909004000
3	Cotter and Clevis pin	
1-4	IMGL, A/C Control Replacement Kit 909510000 Control, IMGL (integrated) Motor, Gear Box, Linkage A/C, Cotter and Clevis pin, Four-way pigtail, Fasteners	909770000

Door Switches		
Part # White* (Closed)	Part # Black** (Open)	Description
905312000	905323000	Magnetic, small rectangular
905314000	905324000	Magnetic, 3/4" core round
905306000	905326000	Magnetic, large rectangular
905307000	905327000	Magnetic, 3/8" core round
905302000	905328000	Plated plunger switch

* Used for all color controls manufactured prior to 2/99. Does NOT include "black" 909506000, 909507000.
** Used for "black" controls since 2/99 including 909506000, 909507000, and 909508000.

Rocker Style Power Switch	
Part #	Description
905305000	For all fully automatic steps.

Self-Center Rocker Switch	
Part #	Description
905316000	For steps NOT equipped with control units.



34 SERIES

Step Replacement Guide

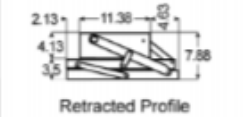
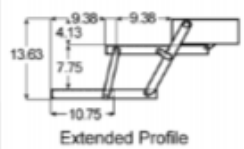
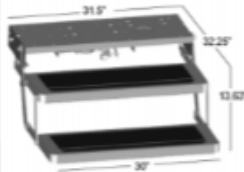

STEP SERIES NUMBER
To determine correct replacement part numbers, it is necessary to know the **Step Series Number**. It is located in the Owners Manual and printed under the top step. If you can not locate the number, measure the step and refer to the dimensioned drawings above. Confirm that you are using the correct step series replacement parts guide.

RISE: 7" RUN: 9"
Mounting bolt pattern: 8 x 26"

Part #903400016
30" tread with Motor and Switch Kit (#905316000)

Part #903406025
30" tread with Motor, Control Unit and Switch Kit (#905325000)

Motor Assembly Drawing and Parts Key Numbers

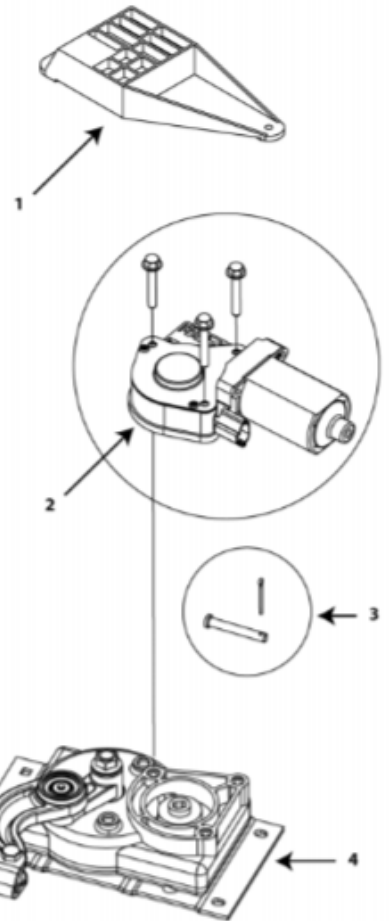

CHART 1
Replacement Parts Kits for Series Steps 22, 23, 30, 32, 33, 34, 35, 36, 38, and 40

Parts Key #	Description	Replacement Kit Part #
1	Control Unit only	
n/a	Step Frame only	908014000
n/a	Step Light only	909004000
3	Cotter and Clevis pin	
1-4	IMGL 'A' Control Replacement Kit 909510000 Control, IMGL integrated Motor, Gear Box, Linkage AJ, Cotter and Clevis pins, Four-way pigtail, Fasteners	909770000

Door Switches

Part # White* (Closed)	Part # Black** (Open)	Description
905312000	905323000	Magnetic, small rectangular
905314000	905324000	Magnetic, 3/4" core round
905306000	905326000	Magnetic, large rectangular
905307000	905327000	Magnetic, 3/8" core round
905302000	905328000	Plated plunger switch

* Used for all color controls manufactured prior to 2/99. Does NOT include "black" 909506000, 909507000.
** Used for "black" controls since 2/99 including 909506000, 909507000, and 909508000.

Rocker Style Power Switch

Part #	Description
905305000	For all fully automatic steps.

Self-Center Rocker Switch

Part #	Description
905316000	For steps NOT equipped with control units.



35 SERIES Step Replacement Guide

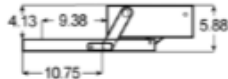
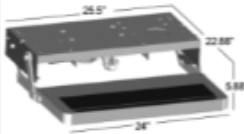

Extended Profile



Retracted Profile

STEP SERIES NUMBER

To determine correct replacement part numbers, it is necessary to know the **Step Series Number**. It is located in the Owners Manual and printed under the top step.

If you can not locate the number, measure the step and refer to the dimensioned drawings above. Confirm that you are using the correct step series replacement parts guide.

RISE: 5" RUN: 10.75"
Mounting bolt pattern: 8 x 22"

Part #903500016
24" tread with Motor and Switch Kit (#905316000)

Part #903506025
24" tread with Motor, Control Unit and Switch Kit (#905325000)

CHART 1 Replacement Parts Kits for Series Steps 22, 23, 30, 32, 33, 34, 35, 36, 38, and 40		
Parts Key #	Description	Replacement Kit Part #
1	Control Unit only	
n/a	Step Frame only	908035000
n/a	Step Light only	909004000
3	Cotter and Clevis pin	
1-4	IMGL "A" Control Replacement Kit 909510000 Control, IMGL (Integrated Motor, Gear Box, Linkage A), Cotter and Clevis pins, Four-way pigtail, Fasteners	909770000

Door Switches		
Part # White* (Closed)	Part # Black** (Open)	Description
905312000	905323000	Magnetic, small rectangular
905314000	905324000	Magnetic, 3/4" core round
905306000	905326000	Magnetic, large rectangular
905307000	905327000	Magnetic, 3/8" core round
905302000	905328000	Plated plunger switch

* Used for all color controls manufactured prior to 2/99. Does NOT include "black" 909506000, 909507000.
** Used for "black" controls since 2/99 including 909506000, 909507000, and 909508000.

Rocker Style Power Switch	
Part #	Description
905305000	For all fully automatic steps.

Self-Center Rocker Switch	
Part #	Description
905316000	For steps NOT equipped with control units.

Motor Assembly Drawing and Parts Key Numbers

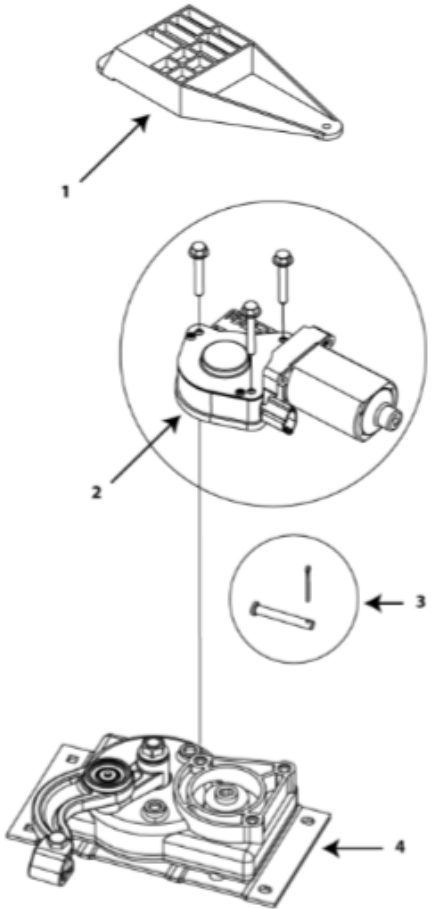



36 SERIES Step Replacement Guide

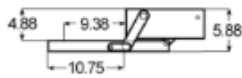
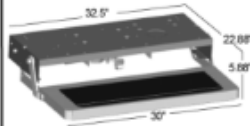

Extended Profile

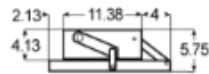

Retracted Profile

STEP SERIES NUMBER

To determine correct replacement part numbers, it is necessary to know the **Step Series Number**. It is located in the Owners Manual and printed under the top step.

If you can not locate the number, measure the step and refer to the dimensioned drawings above. Confirm that you are using the correct step series replacement parts guide.

RISE: 5" RUN: 10.75"
Mounting bolt pattern: 8 x 26"

Part #903600016
30" tread with Motor and Switch Kit (#905316000)

Part #903606025
30" tread with Motor, Control Unit and Switch Kit (#905325000)

Motor Assembly Drawing and Parts Key Numbers

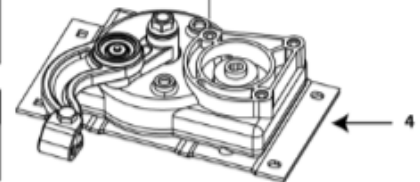
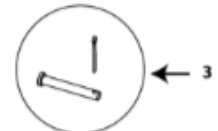
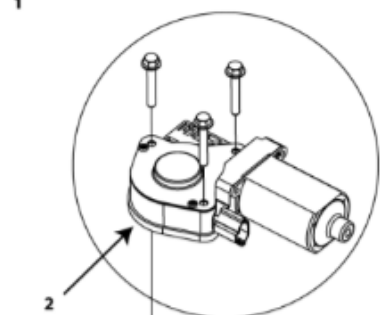
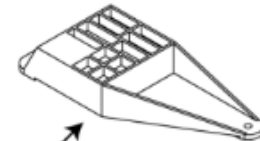

CHART 1 Replacement Parts Kits for Series Steps 22, 23, 30, 32, 33, 34, 35, 36, 38, and 40

Parts Key #	Description	Replacement Kit Part #
1	Control Unit only	
n/a	Step Frame only	908036000
n/a	Step Light only	909004000
3	Cotter and Clevis pin	
1-4	IMGL™ A/Control Replacement Kit 909510000 Control, IMGL (Integrated Motor, Gear Box, Linkage A), Cotter and Clevis pin, Four-way pigtail, Fasteners	909770000

Door Switches

Part # White* (Closed)	Part # Black** (Open)	Description
905312000	905323000	Magnetic, small rectangular
905314000	905324000	Magnetic, 3/4" core round
905306000	905326000	Magnetic, large rectangular
905307000	905327000	Magnetic, 3/8" core round
905302000	905328000	Plated plunger switch

* Used for all color controls manufactured prior to 2/99. Does NOT include "black" 909506000, 909507000.
** Used for "black" controls since 2/99 including 909506000, 909507000, and 909508000.

Rocker Style Power Switch

Part #	Description
905305000	For all fully automatic steps.

Self-Center Rocker Switch

Part #	Description
905316000	For steps NOT equipped with control units.



37 SERIES

Step Replacement Guide

Available with brackets for Van applications

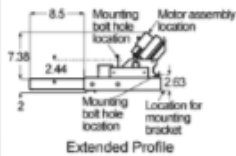
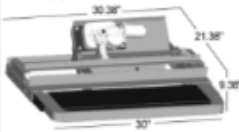

Extended Profile

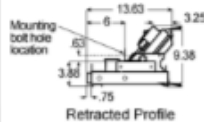

Retracted Profile

STEP SERIES NUMBER

To determine correct replacement part numbers, it is necessary to know the **Step Series Number**. It is located in the Owners Manual and printed under the top step.

If you can not locate the number, measure the step and refer to the dimensioned drawings above. Confirm that you are using the correct step series replacement parts guide.

RISE: 7" RUN: 8.5"
Mounting bolt pattern:
Call for drawing

RV: Part #903700016
30" tread with Motor and Switch Kit (#905316000)

RV: Part #903707025
30" tread with Motor, Control Unit (#909507000) and Switch Kit (#905325000)

VANS: Part #903700000
30" tread with Motor and no Control Unit

VANS:
Part #903707000
30" tread with Motor and Control Unit (#909507000)

Motor Assembly Drawing and Parts Key Numbers

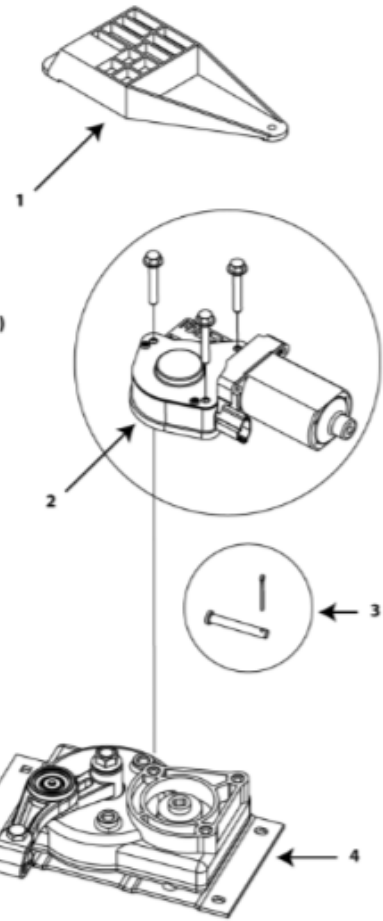

CHART 1 Replacement Parts Kits for Series Steps 22, 23, 30, 32, 33, 34, 35, 36, 38, and 40		
Parts Key #	Description	Replacement Kit Part #
1	Control Unit only	
n/a	Step Frame only	908039000
n/a	Step Light only	909004000
3	Cotter and Clevis pin	
1-4	IMGL 'B' Control Replacement Kit 909510000 Control, IMGL (Integrated Motor, Gear Box, Linkage A), Cotter and Clevis pin, Four-way pigtail, Fasteners	909772000

Door Switches		
Part # White* (Closed)	Part # Black** (Open)	Description
905312000	905323000	Magnetic, small rectangular
905314000	905324000	Magnetic, 3/4" core round
905306000	905326000	Magnetic, large rectangular
905307000	905327000	Magnetic, 3/8" core round
905302000	905328000	Plated plunger switch

* Used for all color controls manufactured prior to 2/99. Does NOT include "black" 909506000, 909507000.
 ** Used for "black" controls since 2/99 including 909506000, 909507000, and 909508000.

Rocker Style Power Switch	
Part #	Description
905305000	For all fully automatic steps.

Self-Center Rocker Switch	
Part #	Description
905316000	For steps NOT equipped with control units.



38 SERIES

Step Replacement Guide

Available with brackets for Van applications

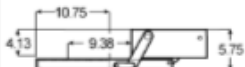
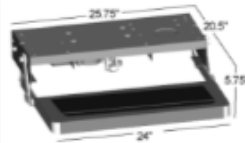

Extended Profile

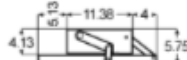

Retracted Profile

STEP SERIES NUMBER

To determine correct replacement part numbers, it is necessary to know the **Step Series Number**. It is located in the Owners Manual and printed under the top step.

If you can not locate the number, measure the step and refer to the dimensioned drawings above. Confirm that you are using the correct step series replacement parts guide.

RISE: 4" RUN: 10.75"
Mounting bolt pattern: 8 x 22"

RV: Part #903800016
24" tread with Motor and Switch Kit (#905316000)

RV: Part #903806025
24" tread with Motor, Control Unit and Switch Kit (#905325000)

VANS:
Part #903800000
24" tread with Motor and no Control Unit

VANS:
Part #903806000
24" tread with Motor and Control Unit

CHART 1 Replacement Parts Kits for Series Steps 22, 23, 30, 32, 33, 34, 35, 36, 38, and 40		
Parts Key #	Description	Replacement Kit Part #
1	Control Unit only	
n/a	Step Frame only	908038000
n/a	Step Light only	909004000
3	Cotter and Clevis pin	
1-4	IMGL 'A' Control Replacement Kit 909510000 Control, IMGL (Integrated Motor, Gear Box, Linkage A), Cotter and Clevis pin, Four-way pigtail, Fasteners	909770000

Door Switches		
Part # White* (Closed)	Part # Black** (Open)	Description
905312000	905323000	Magnetic, small rectangular
905314000	905324000	Magnetic, 3/4" core round
905306000	905326000	Magnetic, large rectangular
905307000	905327000	Magnetic, 3/8" core round
905302000	905328000	Plated plunger switch

* Used for all color controls manufactured prior to 2/99. Does NOT include "black" 909506000, 909507000.
** Used for "black" controls since 2/99 including 909506000, 909507000, and 909508000.

Rocker Style Power Switch	
Part #	Description
905305000	For all fully automatic steps.

Self-Center Rocker Switch	
Part #	Description
905316000	For steps NOT equipped with control units.

Motor Assembly Drawing and Parts Key Numbers

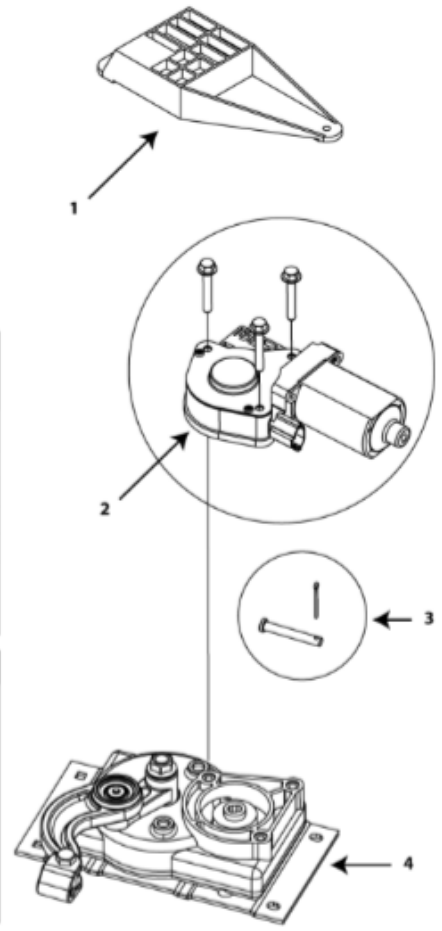



39 SERIES Step Replacement Guide

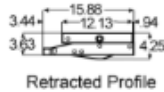
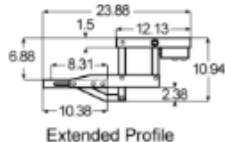
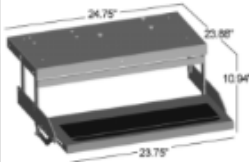

STEP SERIES NUMBER

To determine correct replacement part numbers, it is necessary to know the **Step Series Number**. It is located in the Owners Manual and printed under the top step.

If you can not locate the number, measure the step and refer to the dimensioned drawings above. Confirm that you are using the correct step series replacement parts guide.

RISE: 7" RUN: 10"
Mounting bolt pattern: 7.5 x 20.5"

Part #903900016
23.75" tread with Motor and Switch Kit (#905316000)

Part #903906025
23.75" tread with Motor, Control Unit and Switch Kit (#905325000)

CHART 1 Replacement Parts Kits for Series Steps 22, 23, 30, 32, 33, 34, 35, 36, 38, and 40		
Parts Key #	Description	Replacement Kit Part #
1	Control Unit only	
n/a	Step Frame only	908039000
n/a	Step Light only	909004000
2	Cotter and Clevis pin	
1-4	IMGL 'W' Control Replacement Kit 909510000 Control, IMGL (Integrated Motor, Gear Box, Linkage A), Cotter and Clevis pin, Four-way pigtail, Fasteners	909772000

Door Switches		
Part # White* (Closed)	Part # Black** (Open)	Description
905312000	905323000	Magnetic, small rectangular
905314000	905324000	Magnetic, 3/4" core round
905306000	905326000	Magnetic, large rectangular
905307000	905327000	Magnetic, 3/8" core round
905302000	905328000	Plated plunger switch

* Used for all color controls manufactured prior to 2/99. Does NOT include "black" 909506000, 909507000.
** Used for "black" controls since 2/99 including 909506000, 909507000, and 909508000.

Rocker Style Power Switch	
Part #	Description
905305000	For all fully automatic steps.

Self-Center Rocker Switch	
Part #	Description
905316000	For steps NOT equipped with control units.

Motor Assembly Drawing and Parts Key Numbers

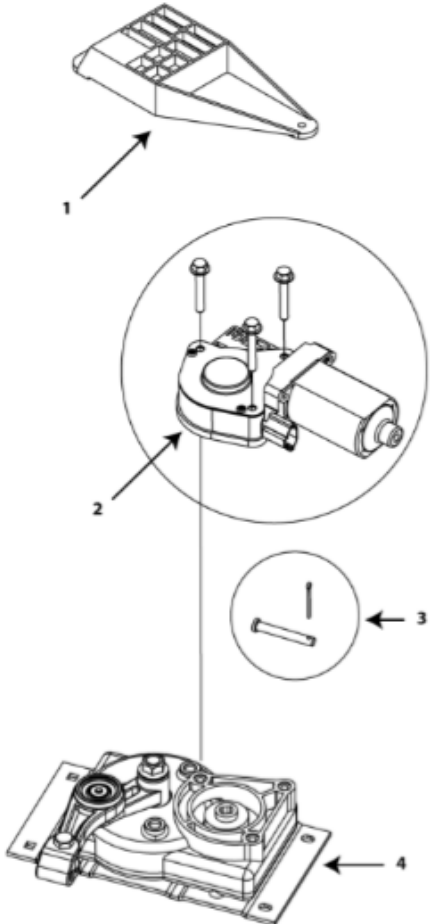



40 SERIES Step Replacement Guide

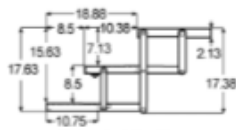
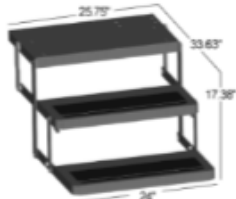

Extended Profile



Retracted Profile

STEP SERIES NUMBER

To determine correct replacement part numbers, it is necessary to know the **Step Series Number**. It is located in the Owners Manual and printed under the top step.

If you can not locate the number, measure the step and refer to the dimensioned drawings above. Confirm that you are using the correct step series replacement parts guide.

RISE: 8" RUN: 10"
Mounting bolt pattern: 12.87 x 20.5"

Part #904000016
24" tread with
High-torque Motor and
Switch Kit (#905316000)

Part #904008025
24" tread with
High-torque Motor,
Control Unit and Switch Kit (#905325000)

Motor Assembly Drawing and Parts Key Numbers

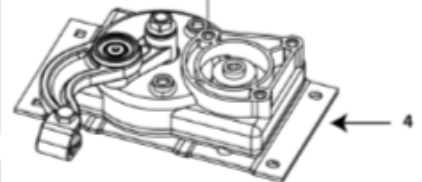
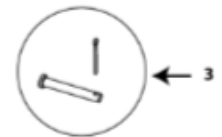
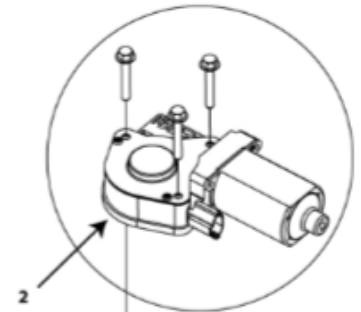
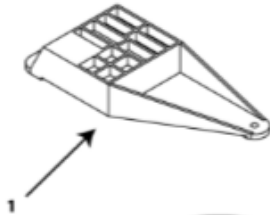

CHART 1 Replacement Parts Kits for Series Steps 22, 23, 30, 32, 33, 34, 35, 36, 38, and 40		
Parts Key #	Description	Replacement Kit Part #
1	Control Unit only	
n/a	Step Frame only	908040000
n/a	Step Light only	909004000
3	Cotter and Clevis pin	
1-4	IMGL 'A' Control Replacement Kit 909510000 Control, IMGL Integrated Motor, Gear Box, Linkage Kit, Cotter and Clevis pin, Four way pigtail, Fasteners	909770000

Door Switches		
Part # White* (Closed)	Part # Black** (Open)	Description
905312000	905323000	Magnetic, small rectangular
905314000	905324000	Magnetic, 3/4" core round
905306000	905326000	Magnetic, large rectangular
905307000	905327000	Magnetic, 3/8" core round
905302000	905328000	Plated plunger switch

* Used for all color controls manufactured prior to 2/99. Does NOT include "black" 909506000, 909507000.
** Used for "black" controls since 2/99 including 909506000, 909507000, and 909508000.

Rocker Style Power Switch	
Part #	Description
905305000	For all fully automatic steps.

Self-Center Rocker Switch	
Part #	Description
905316000	For steps NOT equipped with control units.



Installation Instructions #214

© 2005 Kwikkee Document release date 02/05
Document #1421480

IMGL* and 9510 Control Replacement Kits *Integrated Motor/Gear Box/Linkage

 Before attempting any electric step assembly repair work, please read all of the following instructions.

Disconnect the power at the vehicle battery once the step is extended.

Refer to the Electric Step Replacement Part Schematic, Figure 1, for item numbers referenced in these instructions.

IMGL (Integrated Motor/Gear Box/Linkage) Assembly

Instructions for removing and replacing the IMGL Assembly.

1. On Van Steps, remove plastic splash cover if so equipped. If the step is locked in the retracted (up) position where the plastic cover cannot be removed, the step tread will have to be disassembled to access the plastic cover. To disassemble the tread, remove the (8) 1/4-20 x 1" long hex head bolts in the tread side rails connecting the tread and the sliding blocks to the side rail. This will allow the tread to be dropped out of the way to access the plastic cover. Reassemble the tread after removing the cover.
2. To remove the IMGL assembly from the step it is easiest if the step is partially or fully extended. If possible extend the step with the standard door switch operation.

NOTE: See drawings on Page 2 and 3 for item numbers specified in the following steps.

3. **Steps using a control Unit:** Unplug the 4-way connector to the control unit (Item #6). Disconnect the wiring between the motor and the control unit (Item 7).

Steps without a control Unit: Cut the wires at the butt connectors approximately 12" from the motor.

4. Remove the cotter pin from the clevis pin at the linkage assembly.
5. Remove the clevis pin (Item #2) from the cast "U" block in the end of the linkage assembly (Items #3, #4, or #5). Note the direction the clevis pin goes into the cast block. If the step is in its locked position, the pin may have to be pried or driven out of the block. The step tread(s) should now swing freely, if not check for a bent step frame or jammed pivot point(s).
6. Unbolt the motor assembly from the step frame.
7. Install new IMGL assembly on step frame and tighten all mounting bolts.
8. Install the clevis pin (Item #2) through the drive arms attached to the step frame and the cast block in the linkage assembly (Items #3, #4 or #5). Be sure to reinstall the clevis pin in the same direction it was removed. Install the cotter pin in the clevis pin.
9. Reconnect the wiring:
 - A. Wiring to a 909510000 Control Unit** - Plug the motor connector from the Control Unit into the motor.

B. Wiring to toggle switch only- Using the motor adapter pigtail connect the mating connector to the connector on the motor. Connect the red and yellow pigtail wires to the vehicle switch wires using heat shrink insulated butt connectors.

Plug in the 4-way connector between the control unit and the vehicle.

NOTE: On 23 and 34 Series steps, see the mounting instruction, Figure 3 and 4, when replacing a #8287 double reduction motor with a permanent magnet motor assembly.

IMGL and Control Unit Replacement Kits

Part #	Linkage	For Step Series
909770000	'A'	22, 23, 30, 32, 33, 34, 35, 36, 38, 40
909772000	'B'	28, 31, 37, 39
909774000	'C'	26

Replacement Kits contain an IMGL (integrated motor/gear box/linkage assembly, a Control Unit, four-way pigtail, and fastener kit.

Replacing the motor, gear box, and linkage with the IMGL on a step that has **any control other than a 909510000 Control Unit** (as included) requires the installation of the 909510000 Control included in the Replacement Kit.

Note: Any control unit or motor repair needed on steps using a Delco Field wound motor (part number 8002,8279,8278,8287) requires the IMGL and Control Unit included in the Replacement Kit.

Table of Contents

IMGL Replacement	1
Control Unit Replacement	2
Series 23 & 24 Motor Replacement	4

CONTROL UNIT

Instructions for removing and replacing the control unit.

! Control unit #909510000 requires a normally open switch. If you are replacing a #9513, #9516, #9590 control unit you **MUST** also replace the door switch. The new control will **not** work with older, normally closed switches.

Proceed to the following steps after completing IMGL Assembly Removal steps 1-3.

1. **Controls prior to the 4-way Packard style connector** - Cut the molded rubber 4-way connector pigtail off just above the vehicle half of the butt connectors. Since all manufacturers use different colored wires for vehicle wiring, take a moment to note what color wires from the vehicle are connected to the white, red, brown and yellow wires of the pigtail. Strip the vehicle wires back and connect the new Packard style pigtail connector to the vehicle wiring using heat shrink insulated butt connectors. Make sure that the vehicle wires that were connected to the old pigtail are reattached to the new pigtail in the identical way.

NOTE: Van steps using door switch only operation will have two wires coming from the vehicle. Cut the wires just above the connector and butt connect the pigtail wires to the vehicle wiring. Make sure that the vehicle wires that were connected to the old pigtail are connected to the new pigtail in the identical way.

2. Disconnect the black wire leading from the control unit to the understep light at the connector. Do not cut this wire.

NOTE: Not all steps are equipped with an understep light.

3. On steps with a blue, red, green, yellow, brown, or orange control unit, remove the screw securing the green wire from the control unit to the step frame. Save the screw for securing the green wire on the new control unit. On orange control units manufactured after 1991 remove the screw securing the 31" long 10 ga. green ground wire from the control unit to the vehicle chassis.

IMGL Assembly Drawing and Parts Key Numbers

FIGURE 1

Item Number	Description
1	Motor and screws
2	Cotter and clevis pins
3	Gear box with linkage 'A'
4	Gear box with linkage 'B'
5	Gear box with linkage 'C'

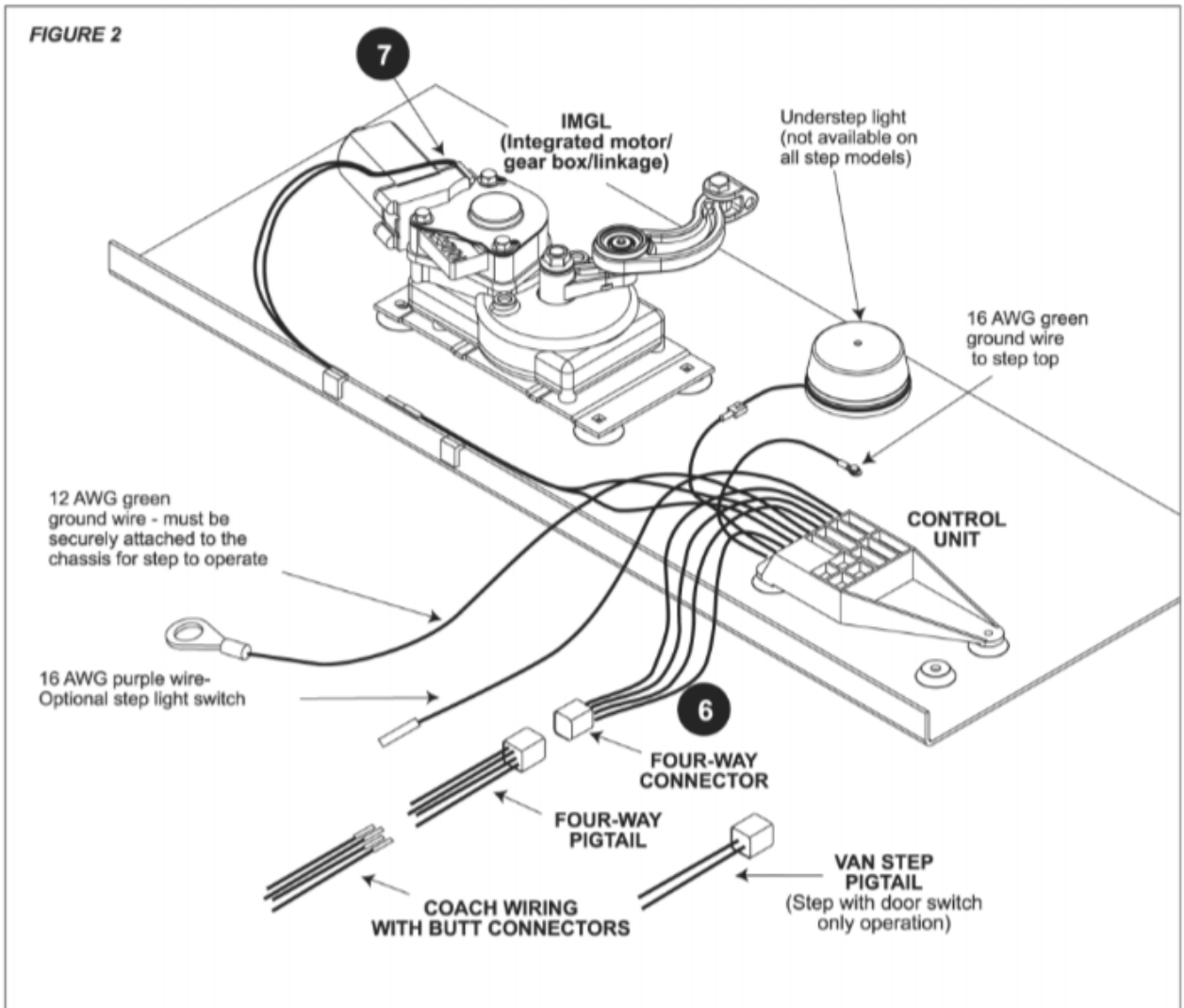

4. Remove the old control unit from the step frame. Save the mounting screws for mounting the new control unit to the step frame.
5. Using the screws saved from the old control, mount the new control to the step frame.
6. Reconnect the wiring:
 - A. Ground the 16 ga. green wire from the control unit to the step frame. Remove any corrosion at the attachment point. Attach it placing the external tooth lock washer supplied with the new control unit between the ring terminal on the end of the green wire and the step frame.

- B. Attach the 31" long 12 ga. green wire to the vehicle chassis. Scrape the connection point clear for a good ground connection. On steps with a braided ground cable, the braided cable may be removed.
- C. Connect the black wire from the control unit to the understep light. On steps not equipped with an understep light, wrap the black wire to protect it from the weather and secure it to keep it from dangling.
- D. Connect the connector to the step motor.

NOTE: The 909510000 Control Unit is to be used only with the AM Equipment 214 motor. The 214 number will be on a sticker on the motor.

7. Reinstall the Splash cover if the step was so equipped.
8. Reconnect the vehicle battery.
9. Test the step functions.

23 and 34 Series Step Motor Replacement

The four-way connector should be disconnected and the old gearbox assembly should already be removed from the step top as previously described.

1. If the step frame is mounted flush against the step mounting surface, the step will have to be removed to access the top side of the step frame.
2. The hole pattern for the new IMGL assembly does not line up properly with the old mounting holes. See **Figure 3** for a mounting diagram for the 23 Series Step and **Figure 4** for the 34 Series Step.

NOTE: All four mounting bolts must be used to attach the motor assembly to the step frame or the step may not operate properly and damage to the step may occur.

3. Bolt down the motor assembly and install the clevis pin and cotter pin as described in IMGL Assembly replacement step #8 on Page 1.
4. Remount the step to the vehicle.

NOTE: If you are installing a control unit, it will be easier to do this while the step is removed from the vehicle.

See Figure 4 for important information on remounting 34 Series steps flush against the step mounting surface.

NOTE A: If the step is mounted flush against the mounting surface, the step must be removed from the vehicle before drilling the 9/32" dia. hole for attaching the motor assembly.

NOTE B: The 1/4" flat washers are used to shim the permanent magnet motor assembly away from the step top so the motor assembly will sit level. This is important for proper step operation.

NOTE C: If the step was originally installed flush against the step well, a 1/4" thick shim may be needed (not provided) so the motor assembly mounting bolt heads will clear the mounting surface.

FIGURE 3: 23 Series Step

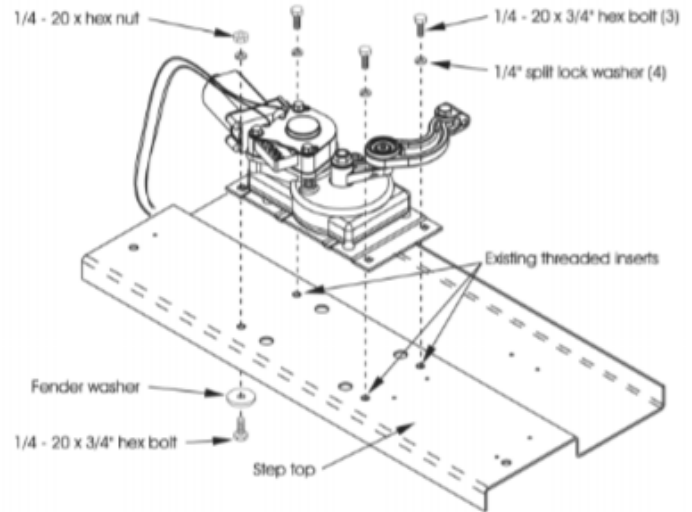
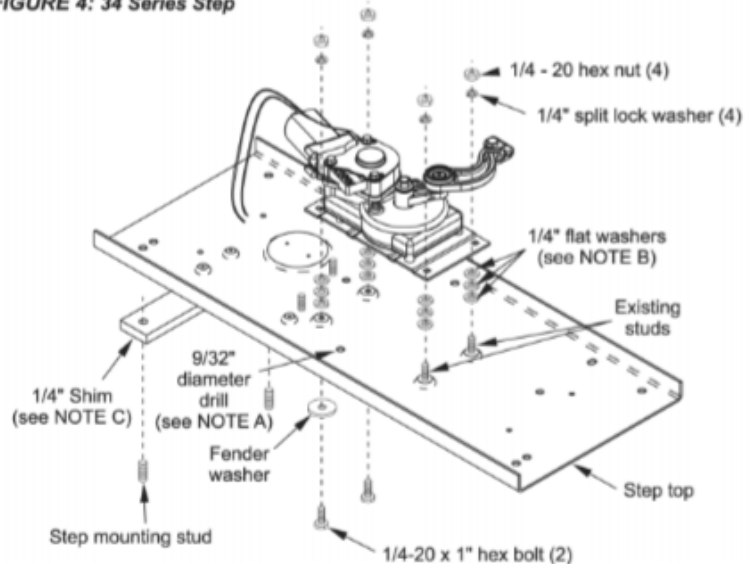

FIGURE 4: 34 Series Step



230 Davidson Avenue
Cottage Grove, Oregon 97424-9545
(541) 942-3888
www.kwikkeepowergear.com

STEP OWNERS MANUALS



888 Owners Manual

For all Kwikkee Electric Steps equipped with the 9095100000 Control Unit -- these steps began shipping in October 2004

880 Owners Manual

For Kwikkee Electric Steps -- except the 42 Series -- equipped with any control other than the 9095100000

842 Owners Manual

For 42 Series Electric Steps equipped with a Permanent Magnet Motor



**Owner's
Manual
#888**

© 9/04 Kwikkee Products Co. Inc.
Kwikkee #1422279 Rev. 1

Electric Steps

Equipped with a Permanent Magnet Motor

(For steps with Control Units 909510000 and steps without Control Units)



Table of Contents

- 2** Warranty Information
- 3** Identification Information
- 4** Introduction
- 5** Operating the Step
- 6** Maintenance:
 - Lubrication
 - Cam Stop Adjustment
- 8** General Service Notes
- 9** Troubleshooting and Testing Procedures



Single Steps

Double Steps

Triple Steps

Van Steps

WARRANTY

For questions regarding these warranty procedures or technical assistance, call 1-800-736-9961.

Be sure to visit us online for updates, and downloadable documents.

**Go to:
www.kwikee.com**

- 1.** We warrant that the equipment is free from defects in material and workmanship under normal use and service. The provisions of this warranty shall not apply to any equipment that has been subject to misuse, negligence, alteration, accident, improper installation (such as the welding of the step to the vehicle frame or mounting brackets), normal deterioration due to wear, or has been repaired outside our place of business in any way as, in our reasonable judgement, to adversely affect its performance and reliability.
- 2.** Our obligation under this warranty is limited to repairing or replacing, at our option, any product that is returned to our place of business and when in its examination shall disclose to our reasonable satisfaction that it is defective. The repair or replacement of the defective parts under this warranty will be made without charge for parts or labor. Shipping charges for returning parts to Kwikkee shall be the responsibility of the customer. Kwikkee will pay shipping charges when returning warrantable parts to the customer. Kwikkee will not accept C.O.D. shipments of any returned goods.
- 3.** The warranty is effective as of the date of sale to the original purchaser and extends two years for parts and labor on step mechanisms and one year for step finish. Since it is the responsibility of the owner to verify the original purchase date, Kwikkee recommends that a bill of sale or sales receipt be kept for that purpose.
- 4.** The duration of any implied warranty of merchantability or fitness for a particular purpose shall be limited in all respects to the duration of the limited warranty, and the warranty described above shall be in lieu of any other express warranty. Some states do not allow limitations on how long implied warranties last, so the above limitations may not apply to you. We neither assume or authorize any other persons to assume any other liability in connection with our products.
- 5.** The buyer's sole and exclusive remedy against the seller shall be for the repair or replacement of defective merchandise as provided above. No other remedy, including but not limited to, incidental or consequential damages for lost profits, lost sales, injury to property or any other incidental or consequential loss, shall be available to him. Some states do not allow the exclusion or limitation of incidental or consequential damages, so the above limitation or exclusion may not apply to you. Before using, user shall determine the suitability of the product for its intended use, and user assumes all risk and liability whatsoever in connection there with.
- 6.** Kwikkee will not, under any circumstances, reimburse the cost of warranty parts purchased from sources other than Kwikkee.
- 7.** This warranty gives you specific legal rights, and you may have other rights which vary from state to state.

WARRANTY GUIDELINES AND PROCEDURES

- 1.** Replace only those parts that are actually defective. Motors, gear cases, gears, linkage assemblies, and control units are all replaceable as individual parts. If you exchange a complete assembly when only the replacement of an individual part is required, the non-defective parts will be returned and only the defective part will be credited to you or replaced.
- 2.** Do not use conversion kits for warranty repairs. Conversion kits are intended for the conversion of older steps with field-wound motors to the newer permanent magnet motor system.
- 3.** A Returned Goods Authorization (RGA) number must be obtained before any parts or claims are sent in. Call Kwikkee's Service Line at 1-800-736-9961 for an RGA number.
- 4.** Our warranty does not cover travel time, mileage, or other incidental costs. It is limited solely to the replacement of defective parts under warranty.

FILL OUT AND SAVE WITH VEHICLE RECORDS

In the event that servicing the step becomes necessary, the information that you supply below will improve service response time. The Step Series number, Serial number, and Control Unit numbers are on the identification labels attached to the control unit and the underside of the step, near the motor. Please take a moment to record this information:

Step Serial #	Step Series #
Year / Make / Model of RV	
Date of Purchase	
CONTROL UNIT Complete the following only if your step is equipped with Control Unit.	
Control Unit Serial #	Control Unit #

STEP IDENTIFICATION AND REPLACEMENT PARTS INFORMATION

To determine replacement parts, refer to the chart for your Series Step.

CHART 1 Replacement Parts Kits for Series Steps 22, 23, 30, 32, 33, 34, 35, 36, 38, and 40		
Parts Key #	Description	Replacement Kit Part #
1	Motor and screws 214	1101428
2	Cotter and Clevis pin	905205000
3	Gear/Linkage 'A' Curved	1101425
	Step Frame only	9080**000
		**insert 2 digit Step Series number
	Step Light	909004000

Replacement Parts Kits for Series Steps 28, 31, 37, and 39 As shown in CHART 1 except for the following:		
Parts Key #	Description	Replacement Kit Part #
4	Gear/Linkage 'B' Straight	1101426

Replacement Parts Kits for Series Steps 26 As shown in CHART 1 except for the following:		
Parts Key #	Description	Replacement Kit Part #
5	Gear/Linkage 'C' Straight	1101427 5

Replacement Parts All Step Series	
DOOR SWITCHES	
Description	Replacement Part # (Black, Open)
Magnetic, small rectangular 3/4" core round	905323000
Magnetic, large rectangular	905324000
Magnetic, 3/8" core round	905326000
Plated plunger switch	905327000
	905328000

ROCKER STYLE POWER SWITCH	
Description	Replacement Part #
For all fully automatic steps.	905305000

SELF-CENTER ROCKER SWITCH	
Description	Replacement Part #
Steps NOT equipped with control unit:	905316000

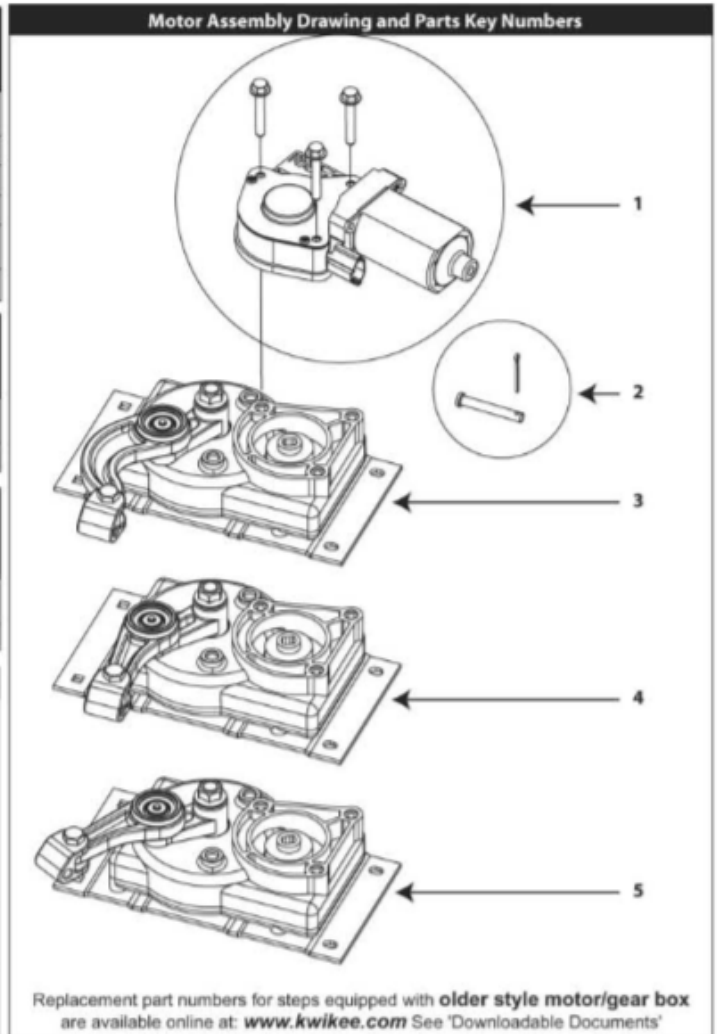

INTRODUCTION

STEPS WITH CONTROL UNIT

This manual has been provided to assist you with the identification, operation, maintenance, and troubleshooting of the Kwikkee electric step equipped with a door switch, override switch, control unit and permanent magnet motor. This manual does not apply and should not be used as a reference to previous versions of a Kwikkee electric step.

The control unit is essentially a current sensor as well as a switching device. When the motor assembly moves the step tread to its extended position, or stops moving because of an obstruction such as a curb or the binding of a damaged or bent step frame, the motor draws a larger amount of current. The control unit 'senses' the larger current draw and shuts off power to the motor.

All control units are equipped with an ignition override system. This system is designed so that the vehicle will not be driven with the step in the extended position. When the step is locked in the extended position (override switch is in the 'on' position), the door closed, and the ignition is turned on, the ignition override system will engage and the step will automatically retract.

The 'Auto Extend' feature is another safety feature designed to extend the step when the door is opened for the first time after the vehicle ignition is turned off, even if the override switch is turned on. When the ignition is switched on, the function of the override switch is disabled and the step will always extend when the door is opened and retract when the door is closed.

Some van steps use door-switch-only operation. When the door is opened the step extends and the step retracts when the door is closed.

NOTE: Follow the instructions in this manual carefully. Failure to do so may result in damage to the step control, the motor and/or the vehicle wiring. Such damage may also result in voiding the warranty.

STEPS WITHOUT CONTROL UNIT

This manual has been provided to assist you with the identification, operation, maintenance, and troubleshooting of the Kwikkee electric step equipped with a self-centering rocker switch. This manual does not apply and should not be used as a reference to previous versions of a Kwikkee electric step.

NOTE: Follow the instructions in this manual carefully. Failure to do so may result in damage to the step, the motor, and/or the vehicle wiring. Such damage may also result in voiding the warranty.

STEPS WITH CONTROL UNIT

OPERATION

1. After the installation is complete and with the entrance door open, turn the override switch to the 'off' position.

NOTE: Some steps are not equipped with an override switch. They are activated only with a door switch.

2. Close the door. The step should retract and lock in the 'up' position.

3. Open the door. The step should extend and lock in the 'down' position with the understep light illuminated.

NOTE: The understep light is not available on all step models.

4. If your step is equipped with a override switch, turn it to the 'on' position. The step should remain in the extended position with the understep light 'off' when the door is closed.

5. With the override switch turned on, the step extended, and the entrance door closed, turn the vehicle ignition on. The ignition override system will go into effect and the step will automatically retract.

NOTE: If the yellow wire from the four-way connector is not connected to an ignition power source, the ignition safety system will be inoperative and the step will remain in the extended position. In this case, the override switch must be turned off for the step to retract.

6. Turn the vehicle ignition off and open the door. The step will extend and lock in the 'down' position. This is the 'Auto Extend' feature.

When the vehicle ignition is turned on, the step will always activate with the door movement, regardless of the override switch position.

NOTE: If the yellow wire from the four-way connector is not connected to an ignition power source, the ignition will not cause the step to retract if the override switch is on, regardless of the door position.



WARNING: If the vehicle is driven with the step in the extended position, there is the possibility of causing major damage to both the step and the vehicle.

STEPS WITHOUT CONTROL UNIT

1. To extend the step, push and hold the bottom half of the rocker switch. Make sure the step is completely extended and locked in position before releasing the switch.

2. Push and hold the top of the rocker switch to retract the step. Be sure the step is completely retracted and locked in position before releasing the switch.

NOTE: Always be sure that the step is fully retracted before traveling. If the step is left extended and strikes an obstruction while the vehicle is moving, major damage to both the step and the vehicle could result.

NOTE: The extend/retract function will be reversed if the red and yellow terminal connections are reversed or the step is equipped with a reverse-driven motor assembly (such as on the 37 and 42 Series steps).



WARNING: Stepping on a partially extended step can cause damage to the step frame.



WARNING: Do not hold the switch in for longer than it takes to either extend or retract the step or damage to the motor will result.

MAINTENANCE

FIGURE 1

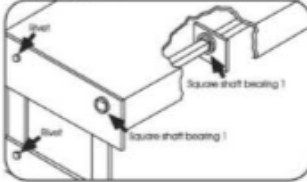

FIGURE 2

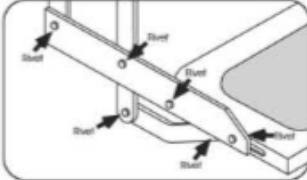

FIGURE 3

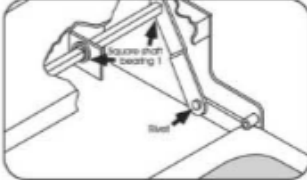

FIGURE 4

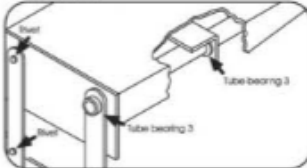

FIGURE 5

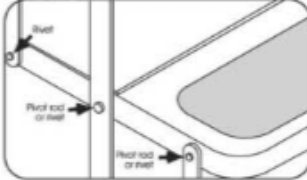

FIGURE 6

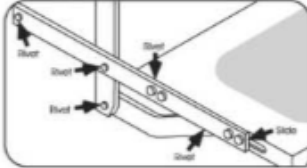
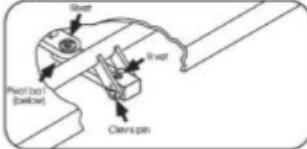

FIGURE 7



LUBRICATION

Clean all mud, salt, and road grime from the step before lubricating. Lubricate all moving parts (bearings, pivot points, slides, clevis pin, and drive linkage ball) every 30 days with a good quality moisture and heat resistant penetrating grease. KwikLube™ Spray Grease is specially formulated to lubricate Kwikkee Electric Steps and is recommended for lubricating all moving parts. Refer to the figures below for lubrication locations.

NOTE: Silicone lubricants and WD-40 are not recommended as they have a tendency to evaporate and dry the mating surfaces which leave them vulnerable to the elements.

NOTE: Figures are to be used for general reference purposes only. Some may not pertain to your particular step model.

- Figures 1 and 3:** Square shaft bearing - lubricate around outside and under head of bearing.
- Figure 4:** On step models equipped with plastic cover, this cover will have to be removed to lubricate center bearings. Lubricate bearings under cover every 90 days.
- Figure 4:** Lubricate around the bushing-in-bushings.
- Maintain clean, dry electrical connections at the two-way and four-way connectors and any butt connections leading from the four-connector to the vehicle. A small dab of dielectric grease at the connections and replacing corroded butt connections with heat shrink type crimp style automotive connectors will help maintain a good electrical source for the step.

KwikLube™ is a unique aerosol grease that has hundreds of automotive, household, and industrial uses in addition to lubricating Kwikkee Electric Steps.

KwikLube sprays on (and into) places that are hard to reach. Then it changes from a penetrating fluid to a **tough, protective grease** in a matter of minutes!

The cured **KwikLube** film is impervious to moisture and can withstand temperatures above 400° F (204° C). This formulation also contains additives to prevent rust and reduce wear.

Ask your local RV Dealer for KwikLube



MAINTENANCE IN SALT ENVIRONMENT

To maintain step finish when step is exposed to a salt environment for extended periods of time, routinely spray step with fresh water.

ADJUSTING THE CAM STOPS

24, 25, 27, 32, 34, 35, 36, 38, and 40 Series Steps

Kwikee steps are fitted with adjustable cam stops on the step frame that help lock the step in the 'out' position, creating a firm stepping platform. The cam is adjusted at the factory but may fall out of adjustment and need to be tightened due to the rigors of shipping, installation, and normal use.

The cam stops are located under the step top on the 32, 36, and 38 Series Steps, and on the bottom tread side rail on the 24, 25, 27 and 40 Series Steps. There is one stop on each side of the step.

CAUTION: When working under the step, be sure that the step cannot be activated and that nothing can get caught in the step mechanism.

1. Loosen the stops so they move freely and retract the step.
2. Extend the step fully to its locked extended position (see **Figure 8**). Be sure that the motor assembly linkage rests against the gear case as illustrated in **Figure 8**. Repeat if needed until the motor assembly locks in the extended position.

3. Push the stops against the leg and tighten securely (see **Figure 9**). Be sure that both stops are tightened and that they rest securely against the leg.

4. Retract and fully extend the step. Check the motor assembly to be sure that it is locked all the way out, and that both stops are secure against the legs. Repeat the above procedures if needed to properly adjust the stops.

5. Push on the front edge of the step tread. If the step seems loose, repeat the above procedures. The stops may not be properly adjusted so that they rest tightly against the leg.

WARNING: When the cam stops are out of adjustment, the step may feel loose or 'mushy' when stepped on. If the cam stops are not properly adjusted the step may not extend fully to the locked-out position. Using a step with loose or out-of-adjustment cam stops may cause damage to the motor assembly and/or the drive linkage.

CAUTION: Be sure that nothing can get caught in the step

FIGURE 8: Gearbox and motor assembly.

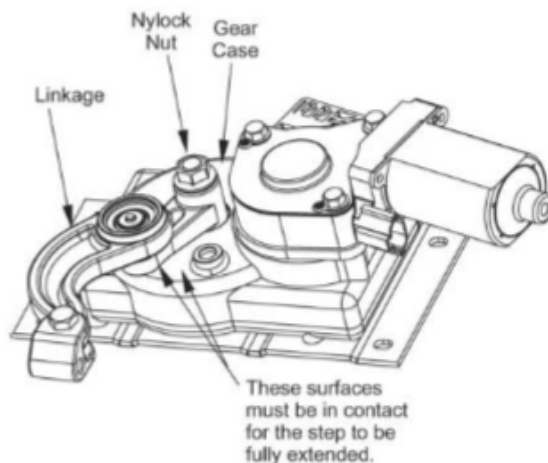
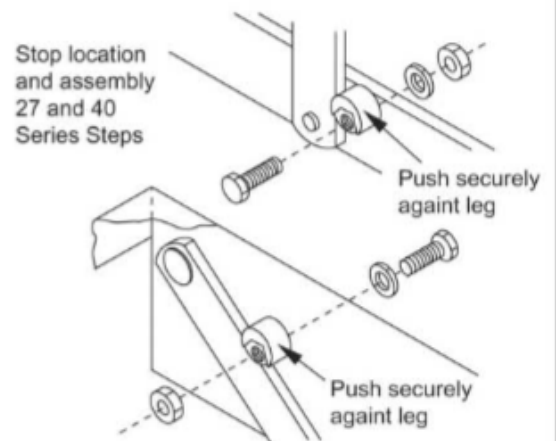

FIGURE 9: Stop location and assembly, 32, 34, 36, and 38 Series Steps



GENERAL SERVICE NOTES

These general service notes and the Step Test Procedures address the most common questions about KwikEE electric steps. Due to the number of variable conditions, you may experience symptoms other than those covered. Please feel free to contact the Customer Service Department at 1-800-736-9961 for further information or assistance.

TROUBLE SHOOTING AND TESTING PROCEDURES

If the power wire to the step is disconnected from its source and reconnected, a spark is common. This is caused by the momentary charging of the control unit and does not necessarily indicate the system is staying on, which would cause a drain on the battery.

To determine if a control unit is not shutting off, remove the four-way connector to the chassis and the two-way connector between the step motor and the control unit. Place a voltmeter between the red and yellow motor wires at the two-way connector from the control unit. Reconnect the four-way Connector. Turn the override switch to the 'off' position. If any voltage registers on the meter for more than 5 seconds, the control unit is not shutting off and may be defective. When doing this test, switch the voltmeter leads back and forth between the red and yellow motor wires to be sure no voltage registers.

If any voltage registers, disconnect the four-way connector to keep the step motor from overheating. If zero voltage is present, the control unit has shut off and is normal.

If the step does not work or operates erratically (for example, extends part way and shuts off) the first item to check is the vehicle battery. Low supply voltage may cause erratic operation of the step. Poor ground connections may also cause erratic operation of the step. Check battery voltage and condition. A battery in good condition and properly charged will have a no load voltage of approx. 12.6 volts. Check the voltage at the battery and at the four-way connector at the control unit. Insure that all battery and step control unit connections are clean and secure. Recharge or replace the battery as necessary and retest the step for proper operation.

The step may also operate erratically if it is operating directly from a converter and the converter output is not adequate or properly filtered for clean DC voltage. The converter must be capable of producing a minimum of 30 amps for proper step operation.

The step will not function if the ground to the control unit is lost between the step control unit and the vehicle chassis (the long green ground wire) or between the vehicle battery and the ground (negative battery cable). Make sure the battery terminals and all wire connections are clean and tight. Verify that all wires meet the minimum requirements specified in **Figures 10, 11, and 12** on Page 10.

The step test procedures on Page 9 are provided to troubleshoot and test all KwikEE automatic electric step functions. The procedures are designed to initially check the basic functions of the step separately from the RV wiring to determine whether or not the step is malfunctioning. The procedures test various components of the step until the source of the malfunction is located. Using the procedures will shorten and reduce the time spent troubleshooting.

Some portions of the test procedures require additional equipment. This equipment includes:

- voltmeter
- well charged 12 volt DC automotive battery
- 4-way connector/pigtail (Part #909306000, available from KwikEE).

Read the entire procedure prior to testing. If you need assistance contact KwikEE's Service Line at 1-800-736-9961.

TESTING THE STEP

1. Inspect the step for visible damage that might restrict step operation.
2. Obtain a 4-way pigtail connector (part #909306000) from Kwikkee.
3. Disconnect 4-way connector on underside of step and connect the step-half of the connector to the four-way connector pigtail. **See Figures 10, 11, and 12 on Pages 10 and 11.**
4. Set a fully charged 12 volt DC automotive battery beside the step.

ATTENTION: Do not allow the battery terminals to come in contact

with the step. Complete a ground for the step tests by connecting a 10 gauge wire from the negative (-) battery post to the green ground wire of the control unit.

VAN STEPS

If the van step is equipped with a splash cover, remove the cover to access motor assembly and control unit. If step is locked in retracted (up) position and the plastic cover can not be removed, disassemble the step tread to access the plastic cover.

To disassemble the tread, remove the (8) 1/4-20 x 1" long hex head bolts in tread side rails (connects tread and sliding blocks to side rail. This allows the tread to drop out of the way and the plastic cover to be accessible.

Reassemble the tread after removing the cover. Reinstall the cover after testing procedures and any necessary repairs are complete. Fully extend the step to reinstall the cover. Be sure that the four-way connector exits the notch in the plastic cover when reassembling.



WARNING: 12 volt automotive batteries contain sulfuric acid which can cause severe burns. Avoid contact with the skin, eyes and clothing. 12 volt automotive batteries produce hydrogen gas which is explosive; keep cigarettes, open flames and sparks away from the battery at all times.

IMPORTANT

INSTALLER NOTES:

Be sure that all ground connections are securely fastened with good metal-to-metal contact. A good ground is required for proper step operation.

5. To supply power, attach the red wire from the pigtail to the battery's positive (+) post. The step will extend.

6. With the power and ground connections complete, all functions of the control unit can be checked at the four wires of the pigtail. The brown wire is the door switch, the white wire is the override switch, and the yellow wire is the ignition override.

7. To retract the step, touch the brown wire to the negative (-) terminal.

8. To extend the step remove the brown wire from the negative (-) terminal.

9. To test the ignition override feature, extend the step as in Step 8. With the step extended, connect the white wire to the positive (+) terminal and attach the brown wire to the negative (-) terminal. Next, touch the yellow wire to the battery's positive (+) terminal. The step should retract. Remove the brown wire and the step should extend.

To test the "Auto Extend" feature, touch the brown wire to the negative (-) terminal to retract the step. While holding the brown wire to the negative (-) terminal, remove the yellow from the positive (+) terminal. Touch the white wire to the positive (+) terminal. The step will stay retracted.

Now, remove the brown wire and the step should extend.

Next touch the brown wire to the negative (-) terminal. The step should stay extended.



WARNING: Keep fingers, arms, and legs clear of step mechanism while performing these tests.

FIGURE 10: Wiring diagram for step with control unit

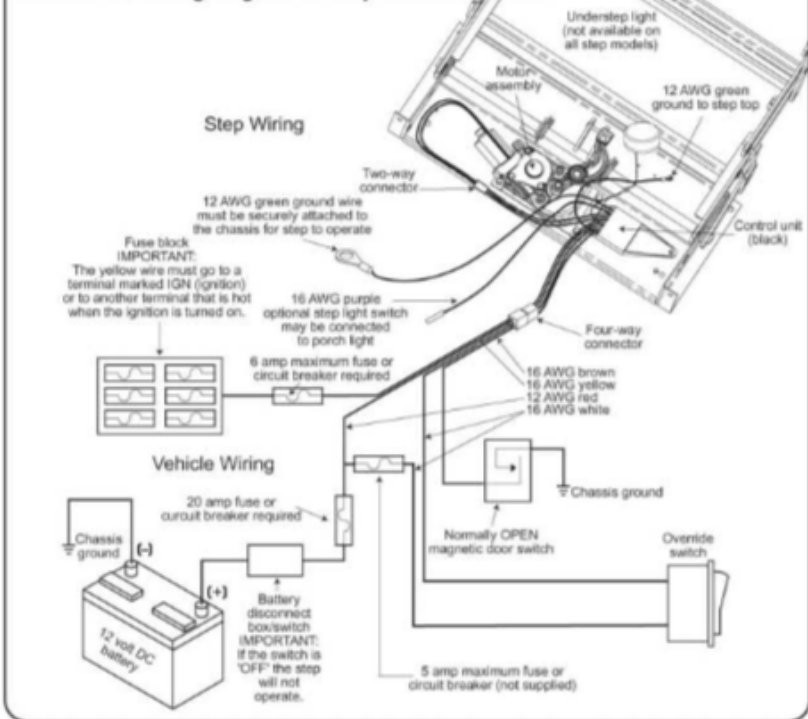

10. If any of the step functions do not work, the source of the malfunction is either in the control unit and/or the motor. Proceed to the "Testing the Motor" section on Page 11.

If all of the step functions do work, the malfunction is either in the door switch, power switch, or the vehicle wiring. Proceed to "Testing the 4-way Connector" section on Page 11.

FIGURE 11: Wiring diagram for steps with door switch only operation

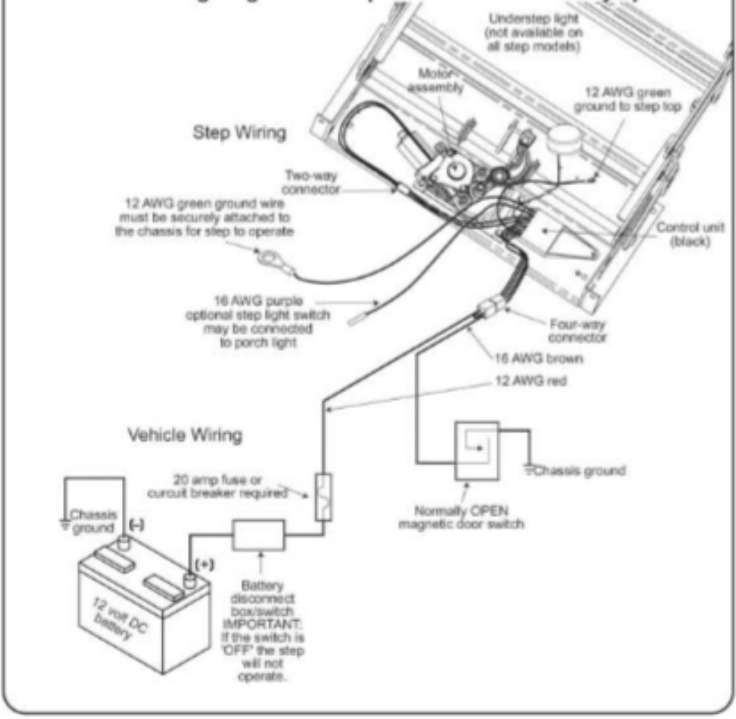
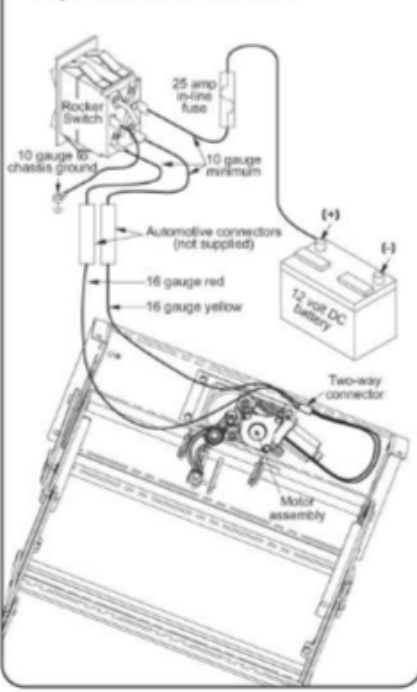

FIGURE 12: Wiring diagram for steps without control unit



TESTING THE MOTOR

- 11.** Disconnect the two-way connector between the step motor and the control unit.

Connect the motor's red wire to the positive (+) terminal of the battery and touch the motor's yellow wire to the negative (-) terminal of the battery to extend the step. To retract the step, reverse the connections. If the step extends and retracts during this test, the condition of the step motor is good.

NOTE: On steps with reverse polarity plug (part number #1800711) reverse the red and yellow wire connections to perform the previous test.

TESTING THE 4-WAY CONNECTOR

- 12.** To check the main power source, connect a voltmeter between the red wire from the 4-way connector (vehicle half) and the ground terminal at the end of the control unit's green ground wire (see **Figure 13**). The reading should be a minimum of 12 volts DC.

If the voltage reading is low, there may be a loose or corroded connection at the battery, a low charge level on the battery itself, or a poor ground. If the voltage reading is zero (0) volts, check the step fuse/circuit breaker, all connections, and the condition of the wiring between the battery and the plug, including the ground connection at the chassis.

- 13.** To check the override switch, connect a voltmeter between the white wire from the 4-way connector (vehicle half) and the terminal at the end of the control unit's green ground wire (see **Figure 14**). The reading should be a minimum of 12 volts DC (the same as in Step 12) when the switch is on, and zero (0) volts DC when the switch is off.

If the voltmeter reads zero (0) volts when the override switch is on, there is a problem in the power switch circuit.

Check the 6 amp in-line fuse, the override switch itself and the condition of the circuit's wiring and terminal connections.

- 14.** To check the door switch, connect a voltmeter between the red wire from the 4-way connector (vehicle half) and the brown in the same connector (see **Figure 15**). The voltage should be a minimum of 12 volts DC (the same as in step 12) when the door is closed and zero (0) volts when the door is open.

If the readings are incorrect, there is a problem with the switch. Check the door switch and the condition of the circuit's wiring and terminal connections.

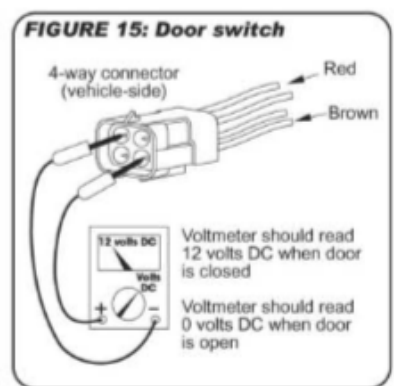
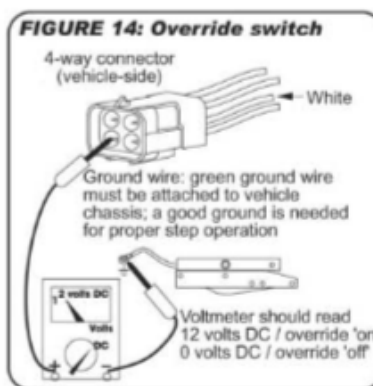
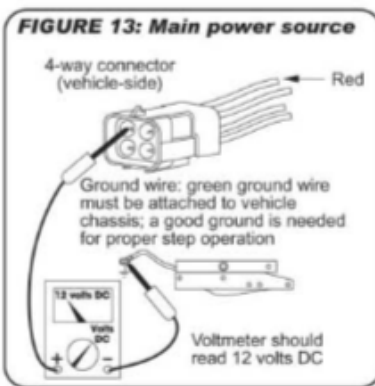
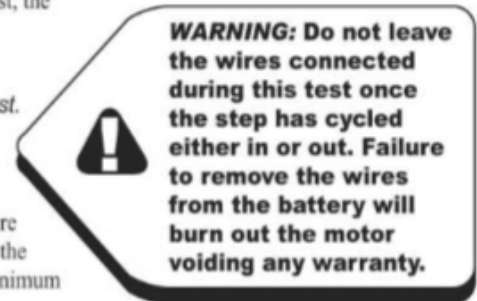

15. To check the ignition override system, connect a voltmeter between the yellow wire from the 4-way connector (vehicle half) and the ground terminal on the end of the control unit's green ground wire (see **Figure 16** on Page 12.) The voltage reading should be approximately 12 volts DC when ignition is on and zero (0) volts when ignition is off.

If the reading is zero when the ignition is on, check all terminal connections, wiring, and the vehicle's ignition fuse.

NOTE: The step wiring circuit must be independent. No other device (i.e. alarm systems, step well lights, etc.) can be connected to the step wiring circuit. Any device connected to the steps wiring can cause the step to malfunction and will void the warranty.

16. For steps equipped with door switch only operation: Connect the white jumper wire from the vehicle half of the four-way connector and the ground terminal at the end of the control unit's green ground wire (see **Figure 17**).

NOTE: Be sure to use the terminal with only the white wire.

The reading should be zero (0) volts DC. If the voltage reading is more, the white wire is connected to 12 volts and should be cut.

If you have additional questions or need more assistance, contact KwikEE's Service Representative at 1-800-736-9961.

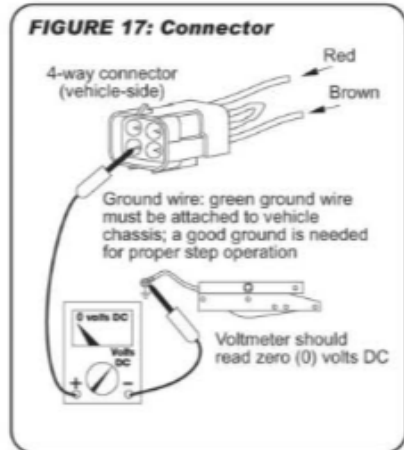

KwikEE

KwikEE Products
230 Davidson Avenue
Cottage Grove, OR 97424-9545
(541) 942-3888

www.kwikEE.com



Wiring Instructions #7543

© 01/05 Kwikkee Kwikkee #1421225 Rev. 2



WARNING: Be sure the vehicle battery is disconnected before starting any wiring procedure.

Before beginning any wiring procedure, be sure you understand the wiring diagram for your particular step model. Be careful to select the proper wire size, length, and color as well as the proper crimp on terminals and connectors for each application as called for in wiring diagram and instruction sheet.

Improper wiring can cause damage to the step control unit and the vehicle's wiring system. Improper wiring will void the step warranty.

Tools needed:

Electric drill
15/32" dia. drill (or 3/8" drill and a round file)
Wire cutters
Wire strippers
Terminal crimper
Electrical tape
Flashlight or drop light
Safety glasses

Kit Contents:

Qty	Description
1	Wiring Harness
1	2' green 16 ga. wire
1	20 amp inline fuse holder
2	5 amp inline fuse holders
8	Wire ties
7	Blue butt connectors
2	Yellow butt connectors
1	1/4" male push on terminal
1	5/16" blue ring terminal
1	5/16" yellow ring terminal
1	#6 blue ring terminal
1	#6 external tooth lock washer
1	1" of caulking compound
1	Power switch (toggle switch)
1	Caution sticker
1	Instructions



230 Davidson Avenue
Cottage Grove, Oregon 97424-9545
(541) 942-3888
www.kwikkee.com

Wiring Installation Instructions

For steps operated by a Door Switch and Power Switch with Control #909510000

NOTE: The step mounting brackets should be mounted and the door switch should be installed before continuing with any wiring.

Installation Instructions

Step 1) Wrap electrical tape around the black plastic loom of the wiring harness every 10-12".

Step 2) Route the wiring harness from the vehicle battery to the step with the four-way Packard-style connector terminating at the step.



WARNING: Keep the wiring harness away from any heat generating or moving parts on the vehicle.

Step 3) Mount the step if not already done. The complete mounting instructions are included with the step mounting brackets.

Step 4) Route and attach the brown wire from the wiring harness to the door switch using a blue butt connector

Step 5) Tie any loose wires in place with the wire ties. If necessary, the wire ties can be held in place with a #6 or #8 sheet metal screw (not supplied.)

Step 6) Under the hood, feed the white and yellow wires from the wiring harness and one end of the separate white 16 ga. wire (not supplied) through the firewall and into the passenger compartment. This may be done through an existing rubber grommet around the speedometer cable or by drilling a hole.



WARNING: Do not drill a hole unless you are absolutely sure there is nothing on the other side of what you are drilling through. Do not feed wires through the firewall where there may be moving parts. Grommet the hole to avoid damaging the wiring.

Step 7) Locate and cut a 15/32" diameter hole in the dash to mount the override switch. Before you drill the hole, be sure that there is enough room to mount the switch behind your hole location. Do not install the switch at this time.

Step 8) Route both white wires to the power switch location, cut to length (leave a little slack), and connect them to the switch using the 1/4" blue female push on terminals. Tie any loose wires in place with the wire ties.

Step 9) Mount the override switch in the dash by inserting it through the hole in the dash from the back side and securing it with the face plate and nut.

Step 10) Run the yellow wire to the vehicle fuse block and cut to length. Cut the orange wire on the 5 amp fuse holder at the halfway point on the loop. Crimp a 1/4" male push on terminal to one lead of the fuse holder. Connect the other lead to the yellow wire with a blue butt connector. Wrap this connection with electrical tape. Connect the wire to the vehicle's fuse block at the terminal marked IGN (ignition) or to another terminal that is hot only when the ignition is turned on.



WARNING: Do not connect the yellow wire to the circuit connected to the vehicle's computer or damage to the computer or the step control unit may result.

Step 11) Under the hood, run the other end white 16 ga. wire from the override switch to the battery location. Cut both the white and red wires to length.

Step 12) Cut the orange wire on the remaining 5 amp fuse holder at the midway point of the loop. Crimp a blue 5/16" ring terminal to one lead of the fuse holder. Connect the other lead to the white wire with a blue butt connector. Wrap this connection with electrical tape.

Step 13) Cut the wire loop on the 20 amp fuse holder at the midway point of the loop. Crimp a yellow 5/16" ring terminal to one lead to the red wire from the wiring harness with a yellow butt connector. Wrap this connection with electrical tape.

Step 14) Connect the red and white wires to the positive (+) battery terminal clamping bolt.

NOTE: Some vehicles have a distribution block located near the battery that is connected directly to the battery. The red and white wires may be connected here instead of the battery clamping bolt.

WARNING: Do not connect this wire into any other circuit in the vehicle. Tie any loose wires in place with the wire ties.

Step 15) At the step, attach the four-way Packard-style connector from the wiring harness to the connector from the step control unit.

Step 16) Reconnect the vehicle battery.

Step 17) Place the "Caution - Stand Clear" sticker on the outside of the van on the window glass or near the door handle where it will be easily seen.

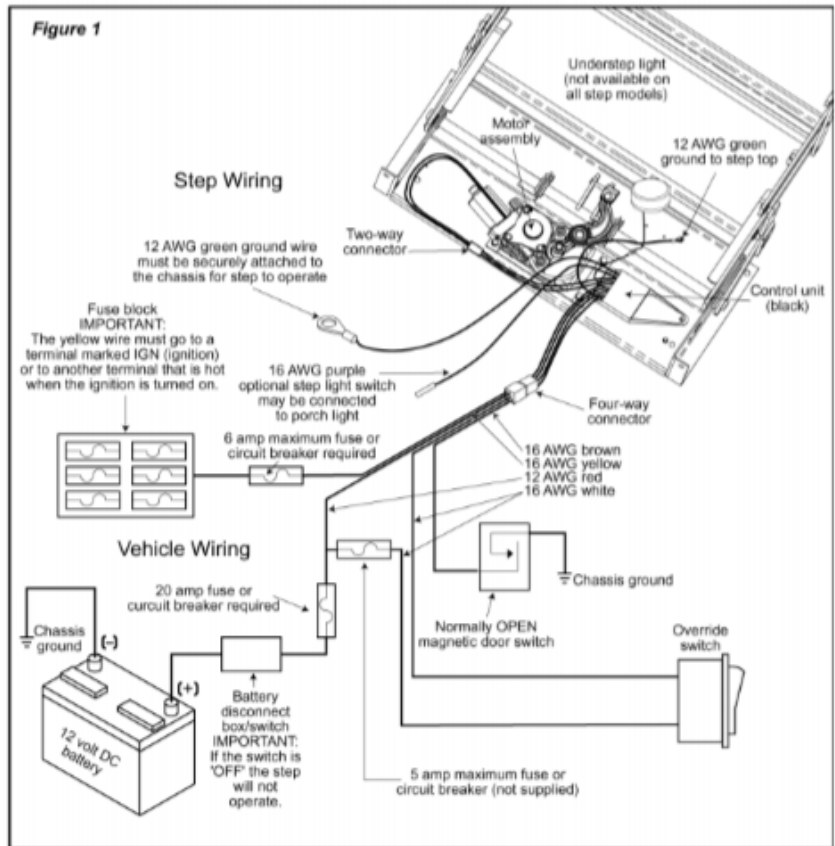

Test Step Operation

Step 18) With the override switch off, close the van door and the step should retract.

Step 19) Open the door and the step should extend.

Step 20) With the door open, turn on the override switch. The step should remain extended when the door is closed.

Step 21) To test the ignition override system, with the step extended, the door closed, and the override switch on, turn on the vehicle ignition and start the vehicle. The step should retract.

WARNING: When the ignition safety system goes into effect and the step automatically retracts, do not open the door until the step completely retracts. If the door is opened before the step completely retracts and locks in the up position, the step will stop moving. The step may only be partially extended. Stepping on a partially extended step may cause damage to the step frame and/or the motor assembly. When the door is closed the step will finish retracting.

If the entrance door is opened at any time the step will extend or stay extended.



230 Davidson Avenue
Cottage Grove, Oregon 97424-9545
(541) 942-3888
www.kwikkee.com



**Owner's
Manual
#880**

© 9/02 Kwikkee Products Co. Inc.
Kwikkee #1422257

Electric Steps

Equipped with a Permanent Magnet Motor

(For steps with Control Units 909506000, 909507000, or 909508000
and steps without Control Units)

INSTALLATION NOTICE

The following information refers to the section of the Owner's Manual titled "Testing the Step," steps 4 and 6. If the step controller unit serial number begins with an "A" and ends with a number less than 0012000 (for example, A0009876), the brown wire of the pigtail must be grounded to initialize the door switch circuitry before the step will extend.

Table of Contents

- 2** Warranty Information
- 3** Identification Information
- 4** Introduction
- 5** Operating the Step
- 6** Maintenance:
 - Lubrication
 - Cam Stop Adjustment
- 8** General Service Notes
- 9** Troubleshooting and Testing Procedures



Single Steps



Double Steps



Triple Steps



Van Steps

WARRANTY

For questions regarding these warranty procedures or technical assistance, call 1-800-736-9961.

Be sure to visit us online for updates, and downloadable documents.

**Go to:
www.kwikee.com**

- 1.** We warrant that the equipment is free from defects in material and workmanship under normal use and service. The provisions of this warranty shall not apply to any equipment that has been subject to misuse, negligence, alteration, accident, improper installation (such as the welding of the step to the vehicle frame or mounting brackets), normal deterioration due to wear, or has been repaired outside our place of business in any way as, in our reasonable judgement, to adversely affect its performance and reliability.
- 2.** Our obligation under this warranty is limited to repairing or replacing, at our option, any product that is returned to our place of business and when in its examination shall disclose to our reasonable satisfaction that it is defective. The repair or replacement of the defective parts under this warranty will be made without charge for parts or labor. Shipping charges for returning parts to Kwikkee Products Company, Inc. ("Kwikkee") shall be the responsibility of the customer. Kwikkee will pay shipping charges when returning warrantable parts to the customer. Kwikkee will not accept C.O.D. shipments of any returned goods.
- 3.** The warranty is effective as of the date of sale to the original purchaser and extends two years for parts and labor on step mechanisms and one year for step finish. Since it is the responsibility of the owner to verify the original purchase date, Kwikkee recommends that a bill of sale or sales receipt be kept for that purpose.
- 4.** The duration of any implied warranty of merchantability or fitness for a particular purpose shall be limited in all respects to the duration of the limited warranty, and the warranty described above shall be in lieu of any other express warranty. Some states do not allow limitations on how long implied warranties last, so the above limitations may not apply to you. We neither assume or authorize any other persons to assume any other liability in connection with our products.
- 5.** The buyer's sole and exclusive remedy against the seller shall be for the repair or replacement of defective merchandise as provided above. No other remedy, including but not limited to, incidental or consequential damages for lost profits, lost sales, injury to property or any other incidental or consequential loss, shall be available to him. Some states do not allow the exclusion or limitation of incidental or consequential damages, so the above limitation or exclusion may not apply to you. Before using, user shall determine the suitability of the product for its intended use, and user assumes all risk and liability whatsoever in connection there with.
- 6.** Kwikkee will not, under any circumstances, reimburse the cost of warranty parts purchased from sources other than Kwikkee Products Company, Inc.
- 7.** This warranty gives you specific legal rights, and you may have other rights which vary from state to state.

WARRANTY GUIDELINES AND PROCEDURES

- 1.** Replace only those parts that are actually defective. Motors, gear cases, gears, linkage assemblies, and control units are all replaceable as individual parts. If you exchange a complete assembly when only the replacement of an individual part is required, the non-defective parts will be returned and only the defective part will be credited to you or replaced.
- 2.** Do not use conversion kits for warranty repairs. Conversion kits are intended for the conversion of older steps with field-wound motors to the newer permanent magnet motor system.
- 3.** A Returned Goods Authorization (RGA) number must be obtained before any parts or claims are sent in. Call Kwikkee's Service Line at 1-800-736-9961 for an RGA number.
- 4.** Our warranty does not cover travel time, mileage, or other incidental costs. It is limited solely to the replacement of defective parts under warranty.

PLEASE NOTE:

The 880 Owners Manual shipped with steps prior to October 2004. Repair parts listed on this page are no longer the manufacturer's recommended repair procedure. See new Replacement Kits listed on Page 7 of this training.

STEP IDENTIFICATION AND REPLACEMENT PARTS INFORMATION

FILL OUT AND SAVE WITH VEHICLE RECORDS

In the event that servicing the step becomes necessary, the information that you supply below will improve service response time. The Step Series number, Serial number, and Control Unit numbers are on the identification labels attached to the control unit and the underside of the step, near the motor. Please take a moment to record this information.

Step Serial # _____ Step Series # _____

Year / Make / Model of RV _____

Date of Purchase _____ Control Unit # _____

CONTROL UNIT Complete the following only if your step is equipped with Control Unit.
Control Unit Serial # _____

To determine replacement parts, refer to the chart for your Series Step.

CHART 1
Replacement Parts Kits for
Series Steps 22, 30, 32, 34, 35, 36, and 38

Parts Key #	Description	Replacement Kit Part #	Parts Key numbers included in kit
1	1/16 x 1 3/4" self-tapping hex weather-head screw	909530050	1, 3, 6, 8, 9, 14
2	Motor bearing bracket	909536090	2
3	Bearing	909520090	1, 3, 6, 8, 9, 14
4A	Motor	909528090	1, 2, 4A, 5B, 16A
5	Adaptor gear	909538090	1, 5A, 5B, 6, 8, 9
6	Adaptor gear shaft	909530090	1, 3, 6, 8, 9, 14
7A	Linkage assembly A	909534090	1, 3, 7A, 8, 9
8	Cutter pin	905205090	8, 9
9	Clevis pin	905305090	8, 9
10	Upper case	909526090	1, 3, 8, 9, 10, 14
11	Main gear	909541090	1, 3, 8, 9, 12, 14
12	Gear case cover	909527090	1, 3, 8, 9, 12, 14
13	Motor mounting plate	909535090	1, 3, 8, 9, 13, 14
14	1/8-20 x 1 1/8" stainless threaded forming screw	909536090	1, 3, 6, 8, 9, 14
16A	Adaptor (signal) (standard)	909520090	1, 2, 4A, 5B, 16A
Step Frame only	9090****090 **Insert 2 digit Step Series number		
Step Light	909004090		

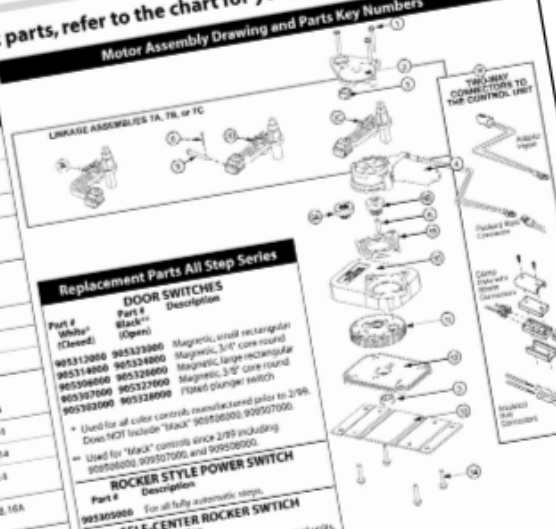

Replacement Parts All Step Series

DOOR SWITCHES

Part #	Parts #	Description
905312090	905320090	Magnetic, small rectangular
905314090	905328090	Magnetic, 3/4" core round
905304090	905324090	Magnetic, large rectangular
905307090	905322090	Magnetic, 3/8" core round
905302090	905326090	Flared plunger switch

* Used for all color controls manufactured prior to 2/98.
Does NOT include "black" 909506090, 909507090.
** Used for "black" controls since 2/99 including 909504090, 909507090, and 909508090.

ROCKER STYLE POWER SWITCH

Part # 905305090 Description: For all fully automatic steps.

SELF-CENTER ROCKER SWITCH

Part # 905316090 Description: For steps NOT equipped with control units.

Replacement Parts Kits for
Series Steps 28, 31, 33, 37, and 39
As shown in CHART 1 except for the following:

Parts Key #	Description	Replacement Kit Part #	Parts Key numbers included in kit
7B	Linkage assembly B	909533090	1, 3, 7B, 8, 9

Replacement Parts Kits for
Series Steps 26
As shown in CHART 1 except for the following:

Parts Key #	Description	Replacement Kit Part #	Parts Key numbers included in kit
7C	Linkage assembly C	909532090	1, 3, 7C, 8, 9

Replacement Parts Kits for
Series Steps 23 and 40
As shown in CHART 1 except for the following:

Parts Key #	Description	Replacement Kit Part #	Parts Key numbers included in kit
2	Motor bearing bracket	909536090	2
4B	Motor (high-torque, use with 23 & 40 Series steps)	909521090	1, 4B, 15, 16B
15	Motor gear case adaptor	909521090	1, 4B, 15, 16B
16B	Adaptor (signal) (high torque)	909521090	1, 4B, 15, 16B

Replacement part numbers are also available online at:
www.kwikkee.com
See 'Downloadable Documents'

Step Identification and Replacement Parts Information / Page 3

Kwikkee Steps Page 46

INTRODUCTION

STEPS WITH CONTROL UNIT

This manual has been provided to assist you with the identification, operation, maintenance, and troubleshooting of any Kwikkee electric step manufactured after January 2002 that is equipped with a door switch, a power switch, control unit and a permanent magnet motor. It does not apply and should not be used as a reference to any other previous versions of a Kwikkee electric step.

The control unit is essentially a current sensor as well as a switching device. When the motor assembly moves the step tread to its extended position, or stops moving because of an obstruction such as a curb or the binding of a damaged or bent step frame, the motor draws a larger amount of current. The control unit "senses" the larger current draw and shuts off power to the motor.

All control units are equipped with an "ignition override system". This system is designed so that the vehicle will not be driven with the step in the extended position. When the step is locked in the extended position, the door closed, and the ignition is turned on, the ignition override system will engage and the step will automatically retract.

The "Last Out" feature is another safety feature designed to extend the step when the door is opened for the first time after the vehicle ignition is turned off, even if the power switch is turned off. When the ignition is switched on, the function of the power switch is disabled and the step will always extend when the door is opened and retract when the door is closed.

Some van steps use door switch only operation. When the door is opened the step extends and the step retracts when the door is closed.

NOTE: Follow the instructions in this manual carefully. Failure to do so may result in damage to the step control, the motor and/or the vehicle wiring. Such damage may also result in voiding the warranty.

STEPS WITHOUT CONTROL UNIT

This manual has been provided to assist you with the identification, operation, maintenance, and troubleshooting of any Kwikkee electric step equipped with the self-centering rocker switch manufactured after January 2002. It does not apply and should not be used as a reference to any other previous versions of a Kwikkee electric step.

NOTE: Follow the instructions in this manual carefully. Failure to do so may result in damage to the step, the motor, and/or the vehicle wiring. Such damage may also result in voiding the warranty.

STEPS WITH CONTROL UNIT

OPERATION

1. After the installation is complete and with the entrance door open, turn the power switch on.

NOTE: Some steps are not equipped with a power switch. They are activated only with a door switch.

2. Close the door. The step should retract and lock in the "up" position.

3. Open the door. The step should extend and lock in the "down" position with the understep light on.

NOTE: The understep light is not available on all step models.

4. If your step is equipped with a power switch, turn it off. The step should remain in the extended position with the understep light off when the door is closed. Turning off the power with the step retracted will hold the step in a retracted position as well.

5. With the power switch off, the step extended, and the entrance door closed, turn on the vehicle ignition. The ignition override system will go into effect and the step will automatically retract.

NOTE: If the yellow wire from the four-way connector is not connected to an ignition power source, the ignition safety system will be inoperative and the step will remain in the extended position. In this case, the power switch must be turned on for the step to retract.



WARNING: If the vehicle is driven with the step in the extended position, there is the possibility of causing major damage to both the step and the vehicle.

6. Turn the vehicle ignition off and open the door. The step will extend and lock in the "down" position. This is the "Last Out" feature.

7. The "Last Out" feature is only operative the first time the door is opened after the vehicle ignition is turned off.

When the vehicle ignition is on, the step will always activate with the door movement, regardless of the power switch position.

NOTE: If the yellow wire from the four-way connector is not connected to an ignition power source, the "Last Out" feature will not operate.

STEPS WITHOUT CONTROL UNIT

1. To extend the step, push and hold the bottom half of the rocker switch. Make sure the step is completely extended and locked in position before releasing the switch.

2. Push and hold the top of the rocker switch to retract the step. Be sure the step is completely retracted and locked in position before releasing the switch.

NOTE: Always be sure that the step is fully retracted before traveling. If the step is left extended and strikes an obstruction while the vehicle is moving, major damage to both the step and the vehicle could result.

NOTE: The extend/retract function will be reversed if the red and yellow terminal connections are reversed or the step is equipped with a reverse-driven motor assembly (such as on the 37 and 42 Series steps).



WARNING: Stepping on a partially extended step can cause damage to the step frame.



WARNING: Do not hold the switch in for longer than it takes to either extend or retract the step or damage to the motor will result.

MAINTENANCE

FIGURE 1

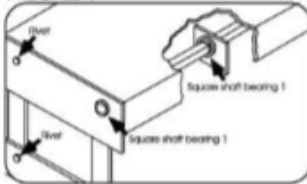

FIGURE 2

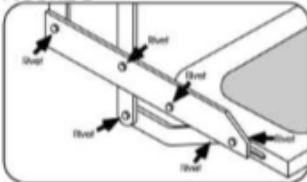

FIGURE 3

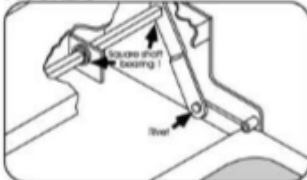

FIGURE 4

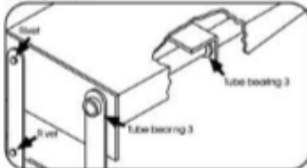

FIGURE 5

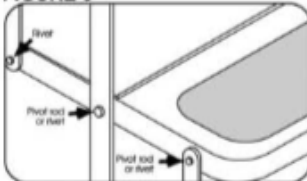

FIGURE 6

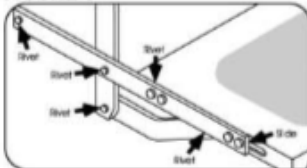
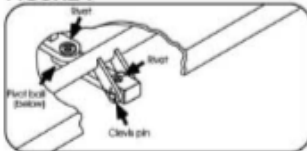

FIGURE 7



LUBRICATION

Clean all mud, salt, and road grime from the step before lubricating. Lubricate all moving parts (bearings, pivot points, slides, clevis pin, and drive linkage ball) every 30 days with a good quality moisture and heat resistant penetrating grease. KwikLube™ Spray Grease is specially formulated to lubricate Kwikkee Electric Steps and is recommended for lubricating all moving parts. Refer to the figures below for lubrication locations.

NOTE: Silicone lubricants and WD-40 are not recommended as they have a tendency to evaporate and dry the mating surfaces which leave them vulnerable to the elements.

NOTE: Figures are to be used for general reference purposes only. Some may not pertain to your particular step model.

- 1. Figures 1 and 3:** Square shaft bearing - lubricate around outside and under head of bearing.
- 2. Figure 4:** On step models equipped with plastic cover, this cover will have to be removed to lubricate center bearings. Lubricate bearings under cover every 90 days.
- 3. Figure 4:** Lubricate around the bushing-in-bushings.
- 4.** Maintain clean, dry electrical connections at the two-way and four-way connectors and any butt connections leading from the four-connector to the vehicle. A small dab of dielectric grease at the connections and replacing corroded butt connections with heat shrink type crimp style automotive connectors will help maintain a good electrical source for the step.

KwikLube™ is a unique aerosol grease that has hundreds of automotive, household, and industrial uses in addition to lubricating Kwikkee Electric Steps.

KwikLube sprays on (and into) places that are hard to reach. Then it changes from a penetrating fluid to a **tough, protective grease** in a matter of minutes!

The cured **KwikLube** film is impervious to moisture and can withstand temperatures above 400° F (204° C). This formulation also contains additives to prevent rust and reduce wear.

Ask your local RV Dealer for KwikLube



MAINTENANCE IN SALT ENVIRONMENT

To maintain step finish when step is exposed to a salt environment for extended periods of time, routinely spray step with fresh water.

ADJUSTING THE CAM STOPS

24, 25, 27, 32, 34, 35, 36, 38, and 40 Series Steps

Kwikee steps are fitted with adjustable cam stops on the step frame that help lock the step in the "out" position, creating a firm stepping platform and relieving load-bearing stress on the motor and drive linkage. The cam is adjusted at the factory but due to the rigors of shipping, installation, and normal use the cam may fall out of adjustment and need to be tightened.

The cam stops are located under the step top on the 32, 36, and 38 Series Steps, and on the bottom tread side rail on the 24, 25, 27 and 40 Series Steps. There is one stop on each side of the step.

CAUTION: When working under the step, be sure that the step cannot be activated and that nothing can get caught in the step mechanism.

1. Loosen the stops so they move freely and retract the step.
2. Extend the step fully to its locked extended position (see *Figure 8*). Be sure that the motor assembly linkage rests against the gear case as illustrated in *Figure 1*. Repeat if needed until the motor assembly locks in the extended position.

3. Push the stops against the leg and tighten securely (see *Figure 9*). Be sure that both stops are tightened and that they rest securely against the leg.

4. Retract and fully extend the step. Check the motor assembly to be sure that it is locked all the way out, and that both stops are secure against the legs. Repeat the above procedures if needed to properly adjust the stops.

5. Push on the front edge of the step tread. If the step seems loose, repeat the above procedures. The stops may not be properly adjusted so that they rest tightly against the leg.

WARNING: When the cam stops are out of adjustment, the step may feel loose or "mushy" when stepped on. If the cam stops are not properly adjusted the step may not extend fully to the locked-out position. Using a step with loose or out-of-adjustment cam stops may cause damage to the motor assembly and/or the drive linkage.

CAUTION: Be sure that nothing can get caught in the step

FIGURE 8: This view shows motor removed and parts exploded for clarity only. These parts need not be disassembled to adjust cam stops.

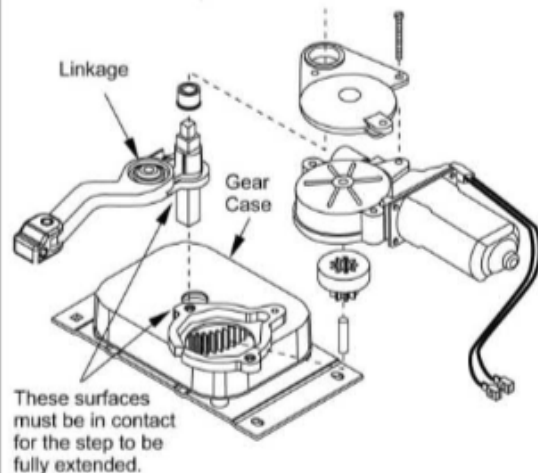
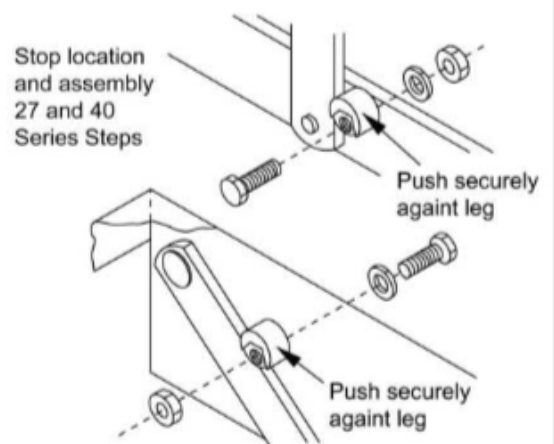

FIGURE 9: Stop location and assembly, 32, 34, 36, and 38 Series Steps



GENERAL SERVICE NOTES

These general service notes and the Step Test Procedures address the most common questions about KwikEE electric steps. Due to the number of variable conditions, you may experience symptoms other than those covered. Please feel free to contact the Customer Service Department at 1-800-736-9961 for further information or assistance.

TROUBLE SHOOTING AND TESTING PROCEDURES

If the power wire to the step is disconnected from its source and reconnected, a spark is common. This is caused by the momentary charging of the control unit and does not necessarily indicate the system is staying on, which would cause a drain on the battery. If battery drain is suspected, observe the understep light (if so equipped) while the step is extending. The power switch must be on for the understep light to operate.

To determine if a control unit is not shutting off, remove the four-way connector to the chassis and the two-way connector between the step motor and the control unit. Place a voltmeter between the red and yellow motor wires at the two-way connector from the control unit. Reconnect the four-way Connector. Turn the power switch on. If any voltage registers on the meter for more than 5 seconds, the control unit is not shutting off and may be defective. When doing this test, switch the voltmeter leads back and forth between the red and yellow motor wires to be sure no voltage registers.

If any voltage does register, disconnect the four-way connector to keep the step motor from overheating. If zero voltage is present, the control unit has shut off and is normal.

If the step does not work or operates erratically, such as extending part way and shutting off, the first item that should be checked is the vehicle's battery. Low supply voltage may cause erratic operation of the step. Poor ground connections may also cause erratic operation of the step. Check battery voltage and condition. A battery in good condition and properly charged will have a no load voltage of approx. 12.6 volts. Check the voltage at the battery and at the four-way connector at the control unit. Insure that all battery and step control unit connections are clean and secure. Recharge or replace the battery as necessary and retest the step for proper operation.

The step may also operate erratically if the step is being operated directly from a converter, and the output from the converter is not adequate or properly filtered for clean DC voltage. The converter must be capable of producing a minimum of 30 amps for proper step operation.

If the ground to the control unit is lost, either between the step control unit and the vehicle chassis (the long green ground wire) or between the vehicle battery and the ground (negative battery cable) the step will not function. Make sure the battery terminals and all wire connections are clean and tight. Verify that all wires meet the minimum requirements specified in **Figures 10, 11, and 12** on Page 10.

The following Step Test Procedures have been provided to troubleshoot and test all of the KwikEE automatic electric step functions. They are designed to initially check the step's basic functions separately from the RV wiring to determine whether or not the step is malfunctioning. The following procedures test the various components of the step until the source of the malfunction is located. Using these procedures will shorten and reduce the time spent troubleshooting.

Some portions of the test procedures require additional equipment. This equipment includes: a voltmeter, a well charged 12 volt DC automotive battery, and a 4-way connector/pigtail (Part #909306000, available from KwikEE Products Company).

Read the entire procedure prior to testing. If you need assistance contact KwikEE's Service Line at 1-800-736-9961.

TESTING THE STEP

1. Inspect the step for visible damage that might restrict the step's operation.
2. Obtain a 4-way pigtail connector (part #909306000) from Kwikkee.
3. Disconnect 4-way connector on underside of step and connect step-half of the connector to the four-way connector pigtail. **See Figures 10, 11, and 12, Page 10-11.**
4. Set a fully charged 12 volt DC automotive battery beside the step.
ATTENTION: Do not allow the battery terminals to come in contact with the step. Complete a ground for the step tests by connecting a 10 gauge wire from the negative (-) battery pos to the green ground wire of the control unit.

VAN STEPS

If the van step is equipped with a splash cover, remove the cover to access motor assembly and control unit. If step is locked in retracted (up) position and the plastic cover can not be removed, disassemble the step tread to access the plastic cover.

To disassemble the tread, remove the (8) 1/4-20 x 1" long hex head bolts in tread side rails (connects tread and sliding blocks to side rail. This allows the tread to drop out of the way and the plastic cover to be accessible.

Reassemble the tread after removing the cover. Reinstall the cover after testing procedures and any necessary repairs are complete. Fully extend the step to reinstall the cover. Be sure that the four-way connector exits the notch in the plastic cover when reassembling.

5. To supply power, attach the red wire from the pigtail to the battery's positive (+) post.

6. With the power and ground connections complete, all functions of the control unit can be checked at the four wires of the pigtail. The brown wire is the door switch, the white wire is the power switch, and the yellow wire is the ignition override.

7. To extend the step, touch the white wire to the battery's positive (+) post. The step should extend and remain extended.

8. To retract the step, hold the white wire to the battery's positive (+) terminal and touch the brown wire to the negative (-) terminal.

9. To test the Ignition Override feature, extend the step as in Step 7. With the step extended, disconnect the white wire from the battery and attach the brown wire to the battery's negative (-) terminal. Next, touch the yellow wire to the battery's positive (+) terminal. The step should retract. Remove the brown wire and the step should extend.

To test the "Last Out" feature, touch the brown wire to the negative (-) terminal to retract the step. While holding the brown wire to the negative (-) terminal, remove the yellow from the positive (+) terminal. The Step will stay retracted. Now, remove the brown wire. The step should extend.



WARNING: 12 volt automotive batteries contain sulfuric acid which can cause severe burns. Avoid contact with the skin, eyes and clothing. 12 volt automotive batteries produce hydrogen gas which is explosive; keep cigarettes, open flames and sparks away from the battery at all times.

IMPORTANT INSTALLER NOTES:

Be sure that all ground connections are securely fastened with good metal-to-metal contact. A good ground is required for proper step operation.



WARNING: Keep fingers, arms, and legs clear of step mechanism while performing these tests.

FIGURE 10: Wiring diagram for step with control unit

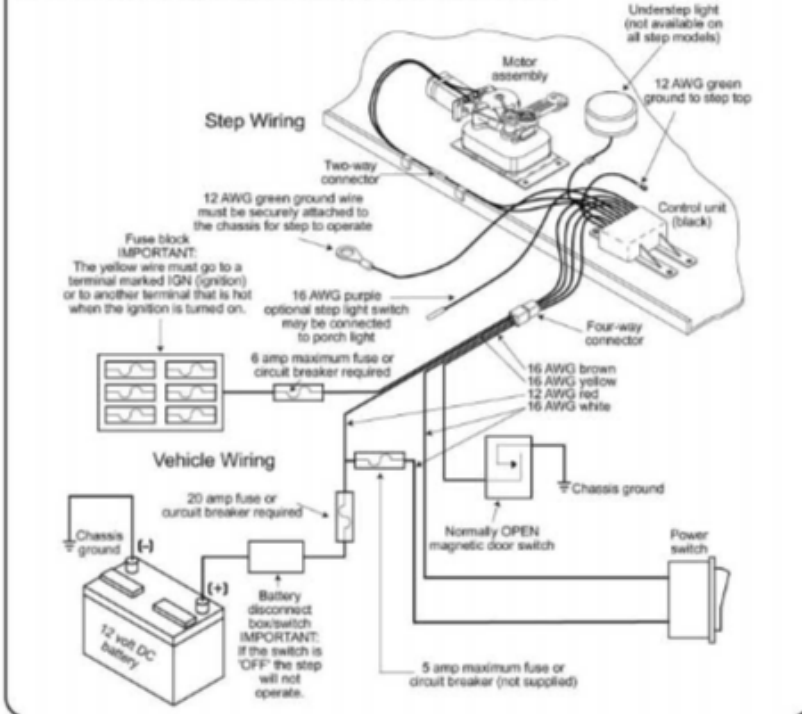

10. If any of the step functions do not work, the source of the malfunction is either in the control unit and/or the motor. Proceed to the "Testing the Motor" section on Page 11.

If all of the step functions do work, the malfunction is either in the door switch, power switch, or the vehicle wiring. Proceed to "Testing the 4-way Connector" section on Page 11.

FIGURE 11: Wiring diagram for steps with door switch only operation

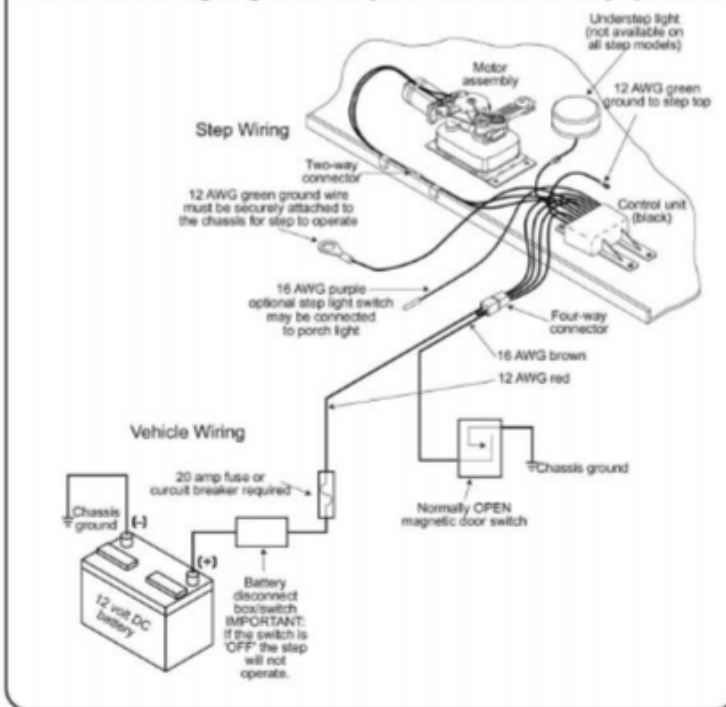
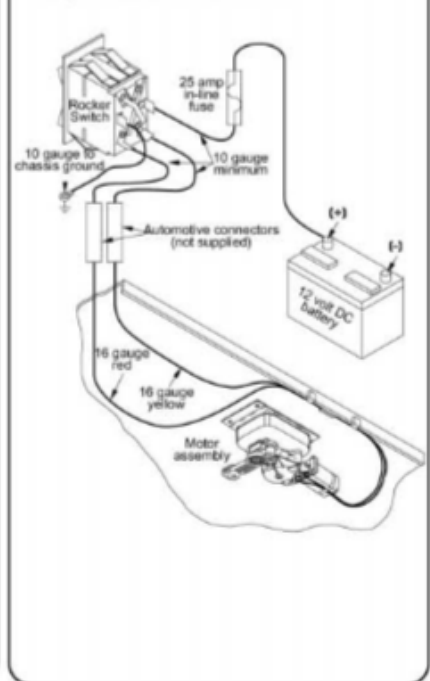

FIGURE 12: Wiring diagram for steps without control unit



TESTING THE MOTOR

- 11.** Disconnect the two-way connector between the step motor and the control unit.

Connect the motor's red wire to the positive (+) terminal of the battery and touch the motor's yellow wire to the negative (-) terminal of the battery to extend the step. To retract the step, reverse the connections. If the step extends and retracts during this test, the condition of the step motor is good.

NOTE: On steps with control unit #909507000 reverse the red and yellow wire connections to perform the aforementioned test.

TESTING THE 4-WAY CONNECTOR

- 12.** To check the main power source, connect a voltmeter between the red wire from the 4-way connector (vehicle half) and the ground terminal at the end of the control unit's green ground wire (see **Figure 13**). The reading should be a minimum of 12 volts DC.

If the voltage reading is low, there may be a loose or corroded connection at the battery, a low charge level on the battery itself, or a poor ground. If the voltage reading is zero (0) volts, check the step fuse/circuit breaker, all connections, and the condition of the wiring between the battery and the plug, including the ground connection at the chassis.

- 13.** To check the power switch, connect a voltmeter between the white wire from the 4-way connector (vehicle half) and the terminal at the end of the control unit's green ground wire (see **Figure 14**). The reading should be a minimum of 12 volts DC (the same as in Step 12) when the switch is on, and zero (0) volts DC when the switch is off.

If the voltmeter reads zero (0) volts when the power switch is on, there is a problem in the power switch circuit.

Check the 6 amp in-line fuse, the power switch itself and the condition of the circuit's wiring and terminal connections.

- 14.** To check the door switch, connect a voltmeter between the red wire from the 4-way connector (vehicle half) and the brown in the same connector (see **Figure 15**). The voltage should be a minimum of 12 volts DC (the same as in step 12) when the door is closed and zero (0) volts when the door is open.

If the readings are incorrect, there is a problem with the switch. Check the door switch and the condition of the circuit's wiring and terminal connections.

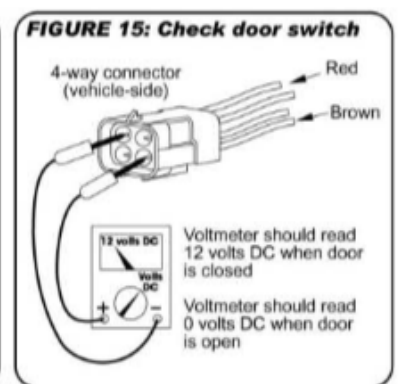
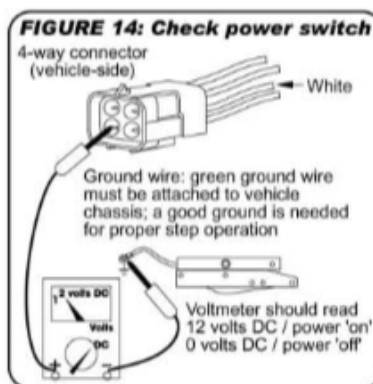
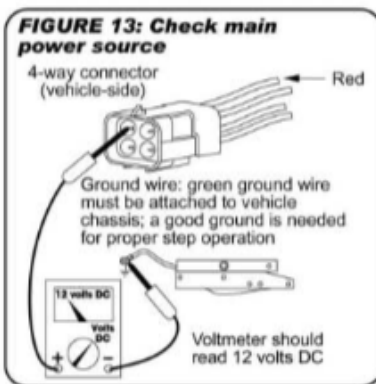
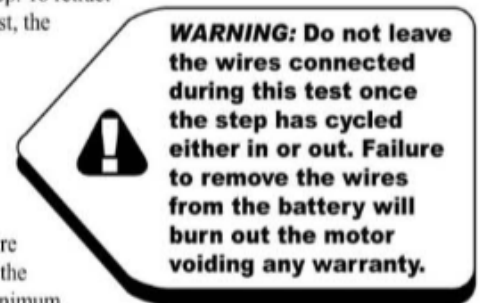

15. To check the ignition override system, connect a voltmeter between the yellow wire from the 4-way connector (vehicle half) and the ground terminal on the end of the control unit's green ground wire (see **Figure 16** on Page 12.) The voltage reading should be approximately 12 volts DC when ignition is on and zero (0) volts when ignition is off.

If the reading is zero when the ignition is on, check all terminal connections, wiring, and the vehicle's ignition fuse.

NOTE: The step wiring circuit must be independent. No other device (i.e. alarm systems, step well lights, etc.) can be connected to the step wiring circuit. Any device connected to the steps wiring can cause the step to malfunction and will void the warranty.

16. For steps equipped with door switch only operation: Connect the white jumper wire from the vehicle half of the four-way connector and the ground terminal at the end of the control unit's green ground wire (see **Figure 17**).

NOTE: Be sure to use the terminal with only the white wire.

The reading should be a minimum of 12 volts DC. If the voltage reading is low, there may be a loose or corroded connection at the battery, a low charge level on the battery itself, or a poor ground. If the voltage reading is zero (0) volts, check the step fuse/circuit breaker, all connections, and the condition of the wiring between the battery and the plug, including the ground connection at the chassis.

If you have additional questions or need more assistance, contact Kwikiee's Service Representative at 1-800-736-9961.

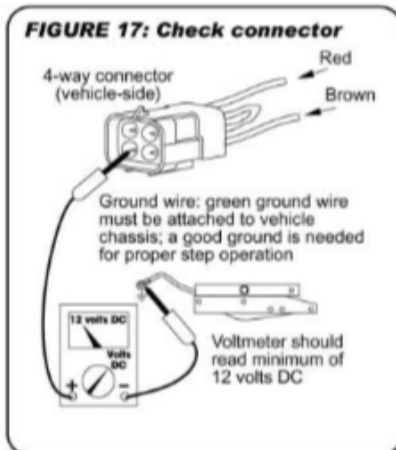
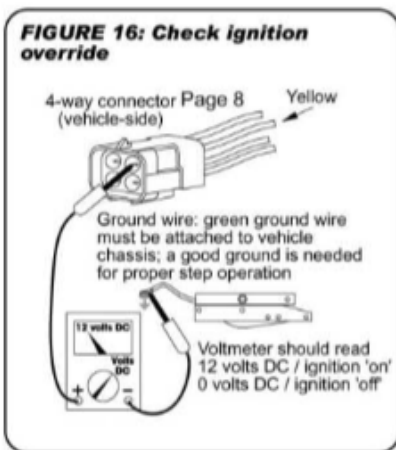

Kwikiee[®]

Kwikiee Products Company, Inc.
230 Davidson Avenue
Cottage Grove, OR 97424-9545
(541) 942-3888

www.kwikiee.com

PLEASE NOTE:

At the time of the printing of this Training, 42 Series Steps have not been changed over to the new IMGL and 909510000 Control Unit. This change is scheduled to happen mid-year 2005 at which time information relating to the control unit, motor, and gearbox will be updated. Check www.kwikee.com downloadable documents for updates.

If you have a service or repair related question, contact the Kwikkee Customer Service Department at 1-800-736-9961.



WARRANTY

For questions regarding these warranty procedures or technical assistance, call 1-800-736-9961.

Be sure to visit us online for updates, and downloadable documents.

**Go to:
www.kwikee.com**

- 1.** We warrant that the equipment is free from defects in material and workmanship under normal use and service. The provisions of this warranty shall not apply to any equipment that has been subject to misuse, negligence, alteration, accident, improper installation (such as the welding of the step to the vehicle frame or mounting brackets), normal deterioration due to wear, or has been repaired outside our place of business in any way as, in our reasonable judgement, to adversely affect its performance and reliability.
- 2.** Our obligation under this warranty is limited to repairing or replacing, at our option, any product that is returned to our place of business and when in its examination shall disclose to our reasonable satisfaction that it is defective. The repair or replacement of the defective parts under this warranty will be made without charge for parts or labor. Shipping charges for returning parts to Kwikkee Products Company, Inc. ("Kwikkee") shall be the responsibility of the customer. Kwikkee will pay shipping charges when returning warrantable parts to the customer. Kwikkee will not accept C.O.D. shipments of any returned goods.
- 3.** The warranty is effective as of the date of sale to the original purchaser and extends two years for parts and labor on step mechanisms and one year for step finish. Since it is the responsibility of the owner to verify the original purchase date, Kwikkee recommends that a bill of sale or sales receipt be kept for that purpose.
- 4.** The duration of any implied warranty of merchantability or fitness for a particular purpose shall be limited in all respects to the duration of the limited warranty, and the warranty described above shall be in lieu of any other express warranty. Some states do not allow limitations on how long implied warranties last, so the above limitations may not apply to you. We neither assume or authorize any other persons to assume any other liability in connection with our products.
- 5.** The buyer's sole and exclusive remedy against the seller shall be for the repair or replacement of defective merchandise as provided above. No other remedy, including but not limited to, incidental or consequential damages for lost profits, lost sales, injury to property or any other incidental or consequential loss, shall be available to him. Some states do not allow the exclusion or limitation of incidental or consequential damages, so the above limitation or exclusion may not apply to you. Before using, user shall determine the suitability of the product for its intended use, and user assumes all risk and liability whatsoever in connection there with.
- 6.** Kwikkee will not, under any circumstances, reimburse the cost of warranty parts purchased from sources other than Kwikkee Products Company, Inc.
- 7.** This warranty gives you specific legal rights, and you may have other rights which vary from state to state.

WARRANTY GUIDELINES AND PROCEDURES

- 1.** Replace only those parts that are actually defective. Motors, gear cases, gears, linkage assemblies, and control units are all replaceable as individual parts. If you exchange a complete assembly when only the replacement of an individual part is required, the non-defective parts will be returned and only the defective part will be credited to you or replaced.
- 2.** Do not use conversion kits for warranty repairs. Conversion kits are intended for the conversion of older steps with field-wound motors to the newer permanent magnet motor system.
- 3.** A Returned Goods Authorization (RGA) number must be obtained before any parts or claims are sent in. Call Kwikkee's Service Line at 1-800-736-9961 for an RGA number.
- 4.** Our warranty does not cover travel time, mileage, or other incidental costs. It is limited solely to the replacement of defective parts under warranty.

FILL OUT AND SAVE WITH VEHICLE RECORDS

In the event that servicing the step becomes necessary, the information that you supply below will improve service response time. The Step Series number, Serial number, and Control Unit numbers are on the identification labels attached to the control unit and the underside of the step, near the motor. Please take a moment to record this information:

Step Serial #	Step Series #
Year / Make / Model of RV	
Date of Purchase	
CONTROL UNIT Complete the following only if your step is equipped with Control Unit.	
Control Unit Serial #	Control Unit #

STEP IDENTIFICATION AND REPLACEMENT PARTS INFORMATION

This manual has been provided to assist you with the identification, operation, maintenance, and troubleshooting of any Kwikkee electric step manufactured after January 2002 that is equipped with a door switch, a power switch, control unit and a permanent magnet motor. It does not apply and should not be used as a reference to any other previous versions of a Kwikkee electric step.

INTRODUCTION

The control unit is essentially a current sensor as well as a switching device. When the motor assembly moves the step tread to its extended position, or stops moving because of an obstruction such as a curb or the binding of a damaged or bent step frame, the motor draws a larger amount of current. The control unit "senses" the larger current draw and shuts off power to the motor.

All control units are equipped with an "ignition override system". This system is designed so that the vehicle will not be driven with the step in the extended position. When the step is locked in the extended position, the door closed, and the ignition is turned on, the ignition override system will engage and the step will automatically retract.

The "Last Out" feature is another safety feature designed to extend the step when the door is opened for the first time after the vehicle ignition is turned off, even if the power switch is turned off. When the ignition is switched on, the function of the power switch is disabled and the step will always extend when the door is opened and retract when the door is closed.

Some van steps use door switch only operation. When the door is opened the step extends and the step retracts when the door is closed.

NOTE: Follow the instructions in this manual carefully. Failure to do so may result in damage to the step control, the motor and/or the vehicle wiring. Such damage may also result in voiding the warranty.

OPERATION

1. After the installation is complete and with the entrance door open, turn the power switch on.

NOTE: Some steps are not equipped with a power switch. They are activated only with a door switch.

2. Close the door. The step should retract and lock in the "in" position.
3. Open the door. The step should extend and lock in the "out" position.

WARNING: If the vehicle is driven with the step in the extended position, there is the possibility of causing major damage to both the step and the vehicle.



4. If your step is equipped with a power switch, turn it off. The step should remain in the extended position when the door is closed. Turning off the power with the step retracted will hold the step in a retracted position as well.
5. With the power switch off, the step extended, and the entrance door closed, turn on the vehicle ignition. The ignition override system will go into effect and the step will automatically retract.

NOTE: If the yellow wire from the four-way connector is not connected to an ignition power source, the ignition safety system will be inoperative and the step will remain in the extended position. In this case, the power switch must be turned on for the step to retract.

6. Turn the vehicle ignition off and open the door. The step will extend and lock in the "out" position. This is the "Last Out" feature.

7. The "Last Out" feature is only operative the first time the door is opened after the vehicle ignition is turned off.

When the vehicle ignition is on, the step will always activate with the door movement, regardless of the power switch position.

NOTE: If the yellow wire from the four-way connector is not connected to an ignition power source, the "Last Out" feature will not operate.

MAINTENANCE

FIGURE 1 Power wash and spray dry lubricant on bearings on both sides of step.

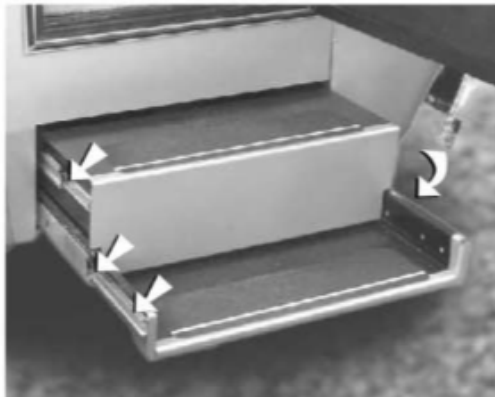

LUBRICATION

1. Clean all mud, salt, and road grime from the step before lubricating. Power wash and spray dry lubricant on the bearings (see **Figure 1**.)

NOTE: Silicone lubricants and WD-40 are not recommended as they have a tendency to evaporate and dry the mating surfaces which leave them vulnerable to the elements.

2. Maintain clean, dry electrical connections at the two-way and four-way connectors and any butt connections leading from the four-connector to the vehicle. A small dab of di-electric grease at the connections and replacing corroded butt connections with heat shrink type crimp style automotive connectors will help maintain a good electrical source for the step.

ADJUSTING THE OUT STOPS

Kwikkee steps are fitted with adjustable out stops on the step frame that help lock the step in the "out" position, creating a firm stepping platform. The out stop is adjusted at the factory but due to the rigors of shipping, installation, and normal use the stop may fall out of adjustment and need to be tightened.



WARNING: When the stops are out of adjustment, the step may feel loose when stepped on.

1. Loosen the stops so they move freely and retract the step.
2. Extend the step fully to its locked extended position. Be sure that the motor assembly linkage rests against the steel plate as illustrated in *Figure 2*. Repeat if needed until the motor assembly locks in the extended position.
3. Push the stops against the lower tread and tighten securely. Be sure that both stops are tightened and that they rest securely against the lower tread.
4. Retract the step. Check to be sure that both stops are secure against the top tread (see *Figure 3*.) Repeat the above procedures if needed to properly adjust the stops.

CAUTION: When working under the step, be sure that the step cannot be activated and that nothing can get caught in the step mechanism.

CAUTION: Be sure that nothing can get caught in the step

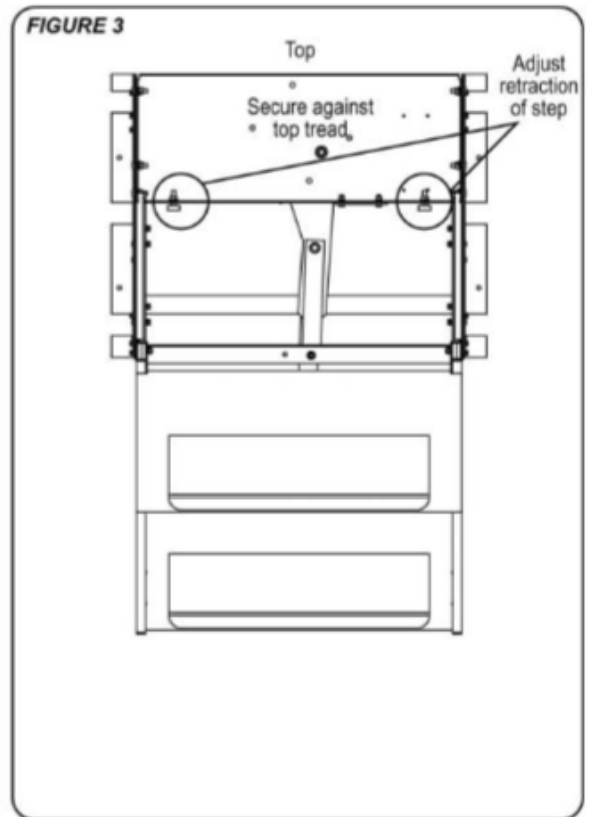
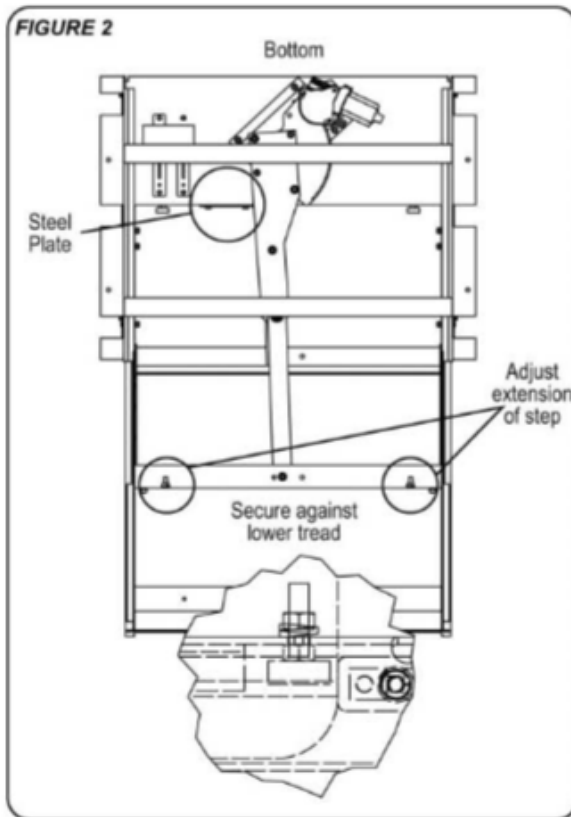

GENERAL SERVICE NOTES

These general service notes and the Step Test Procedures address the most common questions about KwikEE electric steps. Due to the number of variable conditions, you may experience symptoms other than those covered. Please feel free to contact the Customer Service Department at 1-800-736-9961 for further information or assistance.

TROUBLE SHOOTING AND TESTING PROCEDURES

If the power wire to the step is disconnected from its source and reconnected, a spark is common. This is caused by the momentary charging of the control unit and does not necessarily indicate the system is staying on, which would cause a drain on the battery. If battery drain is suspected, observe the understep light (if so equipped) while the step is extending. The power switch must be on for the understep light to operate.

To determine if a control unit is not shutting off, remove the four-way connector to the chassis and the two-way connector between the step motor and the control unit. Place a voltmeter between the red and yellow motor wires at the two-way connector from the control unit. Reconnect the four-way Connector. Turn the power switch on. If any voltage registers on the meter for more than 5 seconds, the control unit is not shutting off and may be defective. When doing this test, switch the voltmeter leads back and forth between the red and yellow motor wires to be sure no voltage registers.

If any voltage does register, disconnect the four-way connector to keep the step motor from overheating. If zero voltage is present, the control unit has shut off and is normal.

If the step does not work or operates erratically, such as extending part way and shutting off, the first item that should be checked is the vehicle's battery. Low supply voltage may cause erratic operation of the step. Poor ground connections may also cause erratic operation of the step. Check battery voltage and condition. A battery in good condition and properly charged will have a no load voltage of approx. 12.6 volts. Check the voltage at the battery and at the four-way connector at the control unit. Insure that all battery and step control unit connections are clean and secure. Recharge or replace the battery as necessary and retest the step for proper operation.

The step may also operate erratically if the step is being operated directly from a converter, and the output from the converter is not adequate or properly filtered for clean DC voltage. The converter must be capable of producing a minimum of 30 amps for proper step operation.

If the ground to the control unit is lost, either between the step control unit and the vehicle chassis (the long green ground wire) or between the vehicle battery and the ground (negative battery cable) the step will not function. Make sure the battery terminals and all wire connections are clean and tight. Verify that all wires meet the minimum requirements specified in **Figures 4 and 5** on Page 8.

The following Step Test Procedures have been provided to troubleshoot and test all of the KwikEE automatic electric step functions. They are designed to initially check the step's basic functions separately from the RV wiring to determine whether or not the step is malfunctioning. The following procedures test the various components of the step until the source of the malfunction is located. Using these procedures will shorten and reduce the time spent troubleshooting.

Some portions of the test procedures require additional equipment. This equipment includes: a voltmeter, a well charged 12 volt DC automotive battery, and a 4-way connector/pigtail (Part #909306000, available from KwikEE Products Company).

Read the entire procedure prior to testing. If you need assistance contact KwikEE's Service Line at 1-800-736-9961.

TESTING THE STEP

1. Inspect the step for visible damage that might restrict the step's operation.
2. Obtain a 4-way pigtail connector (part #909306000) from Kwikkee.
3. Disconnect 4-way connector on underside of step and connect step-half of the connector to the four-way connector pigtail. **See Figures 4 and 5** on Pages 8 and 9.
4. Set a fully charged 12 volt DC automotive battery beside the step.
ATTENTION: Do not allow the battery terminals to come in contact with step.
Complete a ground for step testing by connecting 10 gauge wire from the negative (-) battery post to the green ground wire of the control unit.
5. To supply power, attach the red wire from pigtail to positive (+) post.
6. With the power and ground connections complete, all functions of the control unit can be checked at the four wires of the pigtail. The brown wire is the door switch, the white wire is the power switch, and the yellow wire is the ignition override.
7. To extend the step, touch the white wire to the battery's positive (+) post. The step should extend and remain extended.
8. To retract the step, hold the white wire to the battery's positive (+) terminal and touch the brown wire to the negative (-) terminal.



WARNING: Keep fingers, arms, and legs clear of step mechanism while performing these tests.



WARNING: 12 volt automotive batteries contain sulfuric acid which can cause severe burns. Avoid contact with the skin, eyes and clothing. 12 volt automotive batteries produce hydrogen gas which is explosive; keep cigarettes, open flames and sparks away from the battery at all times.

IMPORTANT INSTALLER NOTES:

Be sure that all ground connections are securely fastened with good metal-to-metal contact. A good ground is required for proper step operation.

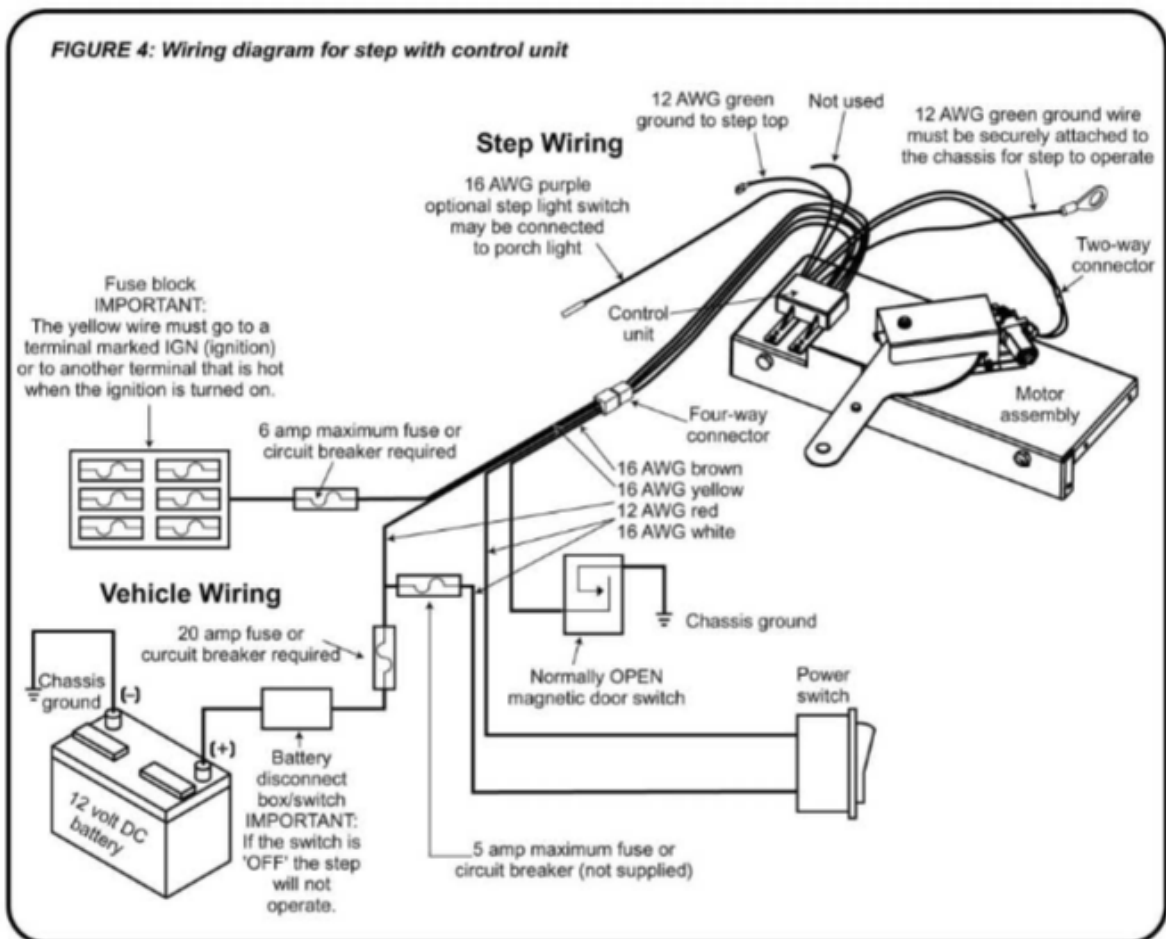

9. To test the Ignition Override feature, extend the step as in Step 7. With the step extended, disconnect the white wire from the battery and attach the brown wire to the battery's negative (-) terminal. Next, touch the yellow wire to the battery's positive (+) terminal. The step should retract. Remove the brown wire and the step should extend.

10. To test the "Last Out" feature, touch the brown wire to the negative (-) terminal to retract the step. While holding the brown wire to the negative (-) terminal, remove the yellow from the positive (+) terminal. The Step will stay retracted. Now, remove the brown wire. The step should extend.

11. If any of the step functions do not work, the source of the malfunction is either in the control unit and/or the motor. Proceed to the "Testing the Motor" section on Page 9.

If all of the step functions do work, the malfunction is either in the door switch, power switch, or the vehicle wiring. Proceed to "Testing the 4-way Connector" section.

FIGURE 5: Wiring diagram for steps with door switch only operation

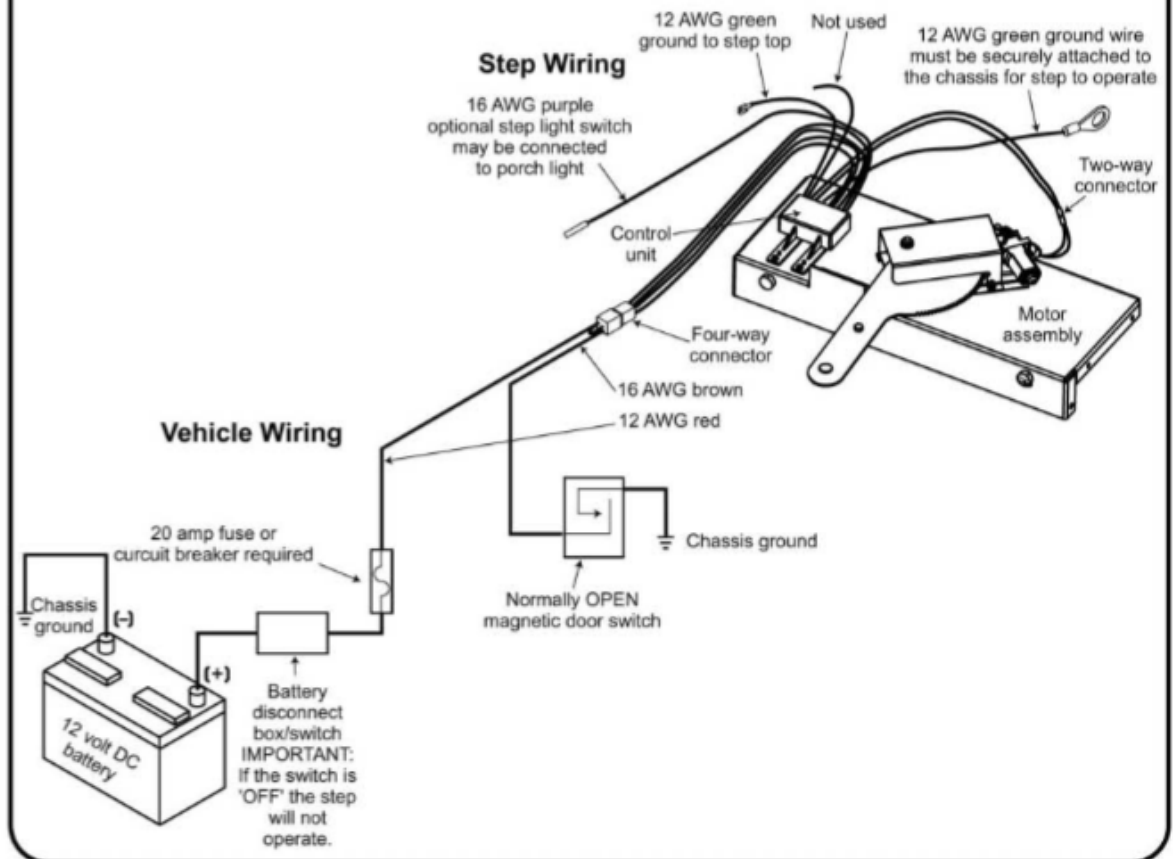

TESTING THE MOTOR

1. Disconnect the two-way connector between the step motor and the control unit.

Connect the motor's yellow wire to the positive (+) terminal of the battery and touch the motor's red wire to the negative (-) terminal of the battery to extend the step. To retract the step, reverse the connections. If the step extends and retracts during this test, the condition of the step motor is good.

TESTING THE 4-WAY CONNECTOR

1. To check the main power source, connect a voltmeter between the red wire from the 4-way connector (vehicle half) and the ground terminal at the end of the control unit's green ground wire (see **Figure 6** on Page 9). The reading should be a minimum of 12 volts DC.

If the voltage reading is low, there may be a loose or corroded connection at the battery, a low charge level on the battery itself, or a poor ground. If the voltage reading is zero (0)

volts, check the step fuse/circuit breaker, all connections, and the condition of the wiring between the battery and the plug, including the ground connection at the chassis.

2. To check the power switch, connect a voltmeter between the white wire from the 4-way connector (vehicle half) and the terminal at the end of the control unit's green ground wire (see **Figure 7**). The reading should be a minimum of 12 volts DC (the same as in Step 1) when the switch is on, and zero (0) volts DC when the switch is off.

WARNING: Do not leave the wires connected during this test once the step has cycled either in or out. Failure to remove the wires from the battery will burn out the motor voiding any warranty.



If the voltmeter reads zero (0) volts when the power switch is on, there is a problem in the power switch circuit.

Check the 6 amp in-line fuse, the power switch itself and the condition of the circuit's wiring and terminal connections.

3. To check the door switch, connect a voltmeter between the red wire from the 4-way connector (vehicle half) and the brown in the same connector (see **Figure 8**) on Page 11). The voltage should be a minimum of 12 volts DC (the same as in Step 1) when the door is closed and zero (0) volts when the door is open.

If the readings are incorrect, there is a problem with the switch. Check the door switch and the condition of the circuit's wiring and terminal connections.

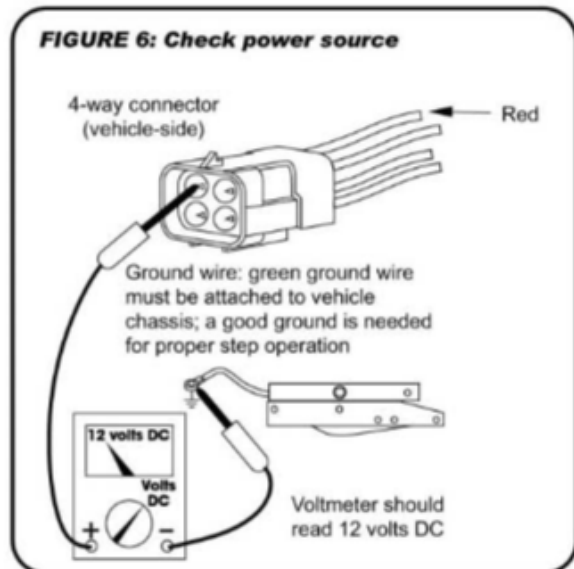

FIGURE 7: Check power switch

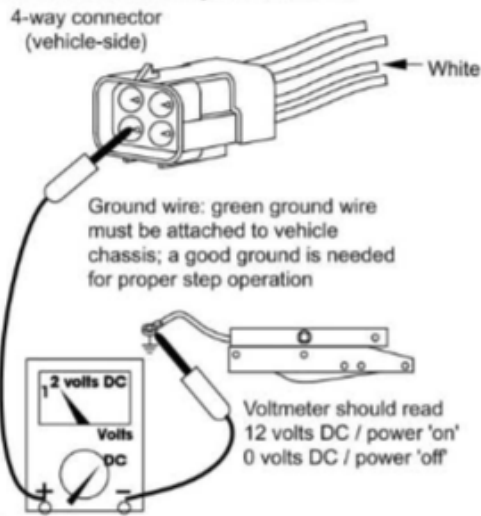

FIGURE 8: Check door switch

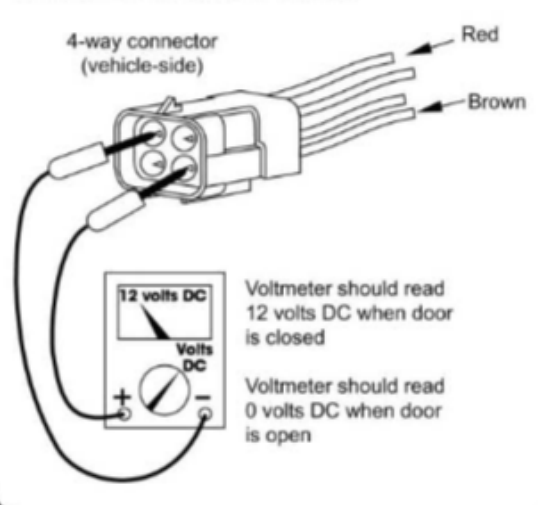

FIGURE 9: Check ignition override

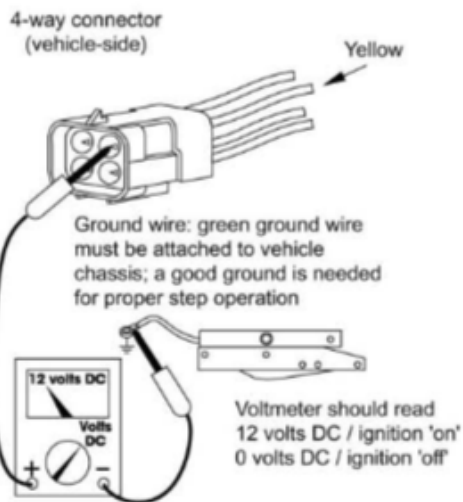
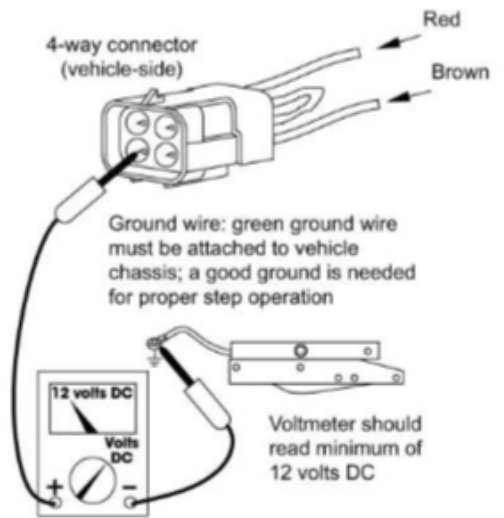

FIGURE 10: Check connector



4. To check the ignition override system, connect a voltmeter between the yellow wire from the 4-way connector (vehicle half) and the ground terminal on the end of the control unit's green ground wire (see **Figure 9**.) The voltage reading should be approximately 12 volts DC when ignition is on and zero (0) volts when ignition is off.

If the reading is zero when the ignition is on, check all terminal connections, wiring, and the vehicle's ignition fuse.

NOTE: *The step wiring circuit must be independent. No other device (i.e. alarm systems, step well lights, etc.) can be connected to the step wiring circuit. Any device connected to the steps wiring can cause the step to malfunction and will void the warranty.*

5. For steps equipped with door switch only operation: Connect the white jumper wire from the vehicle half of the four-way connector and the ground terminal at the end of the control unit's green ground wire (see **Figure 10**).

NOTE: *Be sure to use the terminal with only the white wire.*

The reading should be a minimum of 12 volts DC. If the voltage reading is low, there may be a loose or corroded connection at the battery, a low charge level on the battery itself, or a poor ground. If the voltage reading is zero (0) volts, check the step fuse/circuit breaker, all connections, and the condition of the wiring between the battery and the plug, including the ground connection at the chassis.

If you have additional questions or need more assistance, contact KwikEE's Service Representative at 1-800-736-9961.



230 Davidson Avenue, Cottage Grove, OR 97424-9545
(541) 942-3888
www.kwikEE.com



KwikTest Users Manual #909518000

©2005 Kwikkee Products Co., Inc.
Kwikkee #1420594 Rev. 3



KwikTest Part #909518000
(includes 4-way connector)

KwikTest Users Manual Part #909518000

Connecting the KwikTest unit to the Step (See Figure 1, Page 2)

Step 1) Attach the Packard style four-way connector from the KwikTest to the four-way connector on the step control unit.

Step 2) Connect the red wire clip to the positive post on the battery.

Step 3) Attach one of the green wire clips to the negative post of the battery. Attach the other green wire clip to the ring terminal on the end of the 12 gauge green ground wire coming from the step control unit.

KwikTest Set Up: For all steps except those with Control Unit #909510000

Step 4A) Set the Control Switch to "black" or "white" depending on the color of the control unit on the step being tested.

A. Testing Procedures For all steps except those with Control Unit #909510000

Run the following test a minimum of 6 cycles, allowing 3 to 5 seconds between opening and closing the Door Switch to give the control unit internal relays enough time to reset.

NOTE: On steps fitted with the rubber four-way plug, use the four-way plug/pigtail (included with the KwikTest) to make the connection between the step control unit and the tester.

For steps with other than Control 909510000

For all steps except those with 909510000 Control

Perform tests in sequence listed.	Ignition Switch		Power Switch		Door Switch		Step Function				Step Light	
	OFF	ON	OFF	ON	CLOSED	OPEN	GOES IN	STAYS IN	GOES OUT	STAYS OUT	OFF	ON
Test 1 Settings	■			■	■		<input checked="" type="checkbox"/>	<input type="checkbox"/>	<input type="checkbox"/>	<input type="checkbox"/>	<input checked="" type="checkbox"/>	<input type="checkbox"/>
Test 2 Settings	■			■		■	<input type="checkbox"/>	<input type="checkbox"/>	<input checked="" type="checkbox"/>	<input type="checkbox"/>	<input type="checkbox"/>	<input checked="" type="checkbox"/>
Test 3 Settings	■			■	■		<input checked="" type="checkbox"/>	<input type="checkbox"/>	<input type="checkbox"/>	<input type="checkbox"/>	<input checked="" type="checkbox"/>	<input type="checkbox"/>
Test 4 Settings	■			■		■	<input type="checkbox"/>	<input type="checkbox"/>	<input checked="" type="checkbox"/>	<input type="checkbox"/>	<input type="checkbox"/>	<input checked="" type="checkbox"/>
Test 5 Settings	■		■			■	<input type="checkbox"/>	<input type="checkbox"/>	<input type="checkbox"/>	<input checked="" type="checkbox"/>	<input checked="" type="checkbox"/>	<input type="checkbox"/>
Test 6 Settings	■		■		■		<input type="checkbox"/>	<input type="checkbox"/>	<input type="checkbox"/>	<input checked="" type="checkbox"/>	<input checked="" type="checkbox"/>	<input type="checkbox"/>
Test 7 Settings		■	■		■		<input checked="" type="checkbox"/>	<input type="checkbox"/>	<input type="checkbox"/>	<input type="checkbox"/>	<input checked="" type="checkbox"/>	<input type="checkbox"/>
Test 8 Settings		■	■			■	<input type="checkbox"/>	<input type="checkbox"/>	<input checked="" type="checkbox"/>	<input type="checkbox"/>	<input checked="" type="checkbox"/>	<input type="checkbox"/>
Test 9 Settings		■	■		■		<input checked="" type="checkbox"/>	<input type="checkbox"/>	<input type="checkbox"/>	<input type="checkbox"/>	<input checked="" type="checkbox"/>	<input type="checkbox"/>
Test 10 Settings	■		■		■		<input type="checkbox"/>	<input checked="" type="checkbox"/>	<input type="checkbox"/>	<input type="checkbox"/>	<input checked="" type="checkbox"/>	<input type="checkbox"/>
Test 11 Settings	■		■			■	<input type="checkbox"/>	<input type="checkbox"/>	<input checked="" type="checkbox"/>	<input type="checkbox"/>	<input checked="" type="checkbox"/>	<input type="checkbox"/>

Tests Ignition Override Feature

Tests 'Last Out' Feature

At this point the step should remain extended until one of the following occurs:

- a) The Door Switch is flipped "close" and the Power Switch is in the "on" position, or
- b) The Door Switch is flipped "close" and the Ignition Switch is in the "on" position.

NOTES: (1) The ignition override will not work until the door is closed. (2) For steps fitted with a white control unit, the 'last-out' feature will be disabled by turning the power switch on and then off (between steps 16 and 17), or if the power switch is "on" when the ignition is turned "off" and is then turned "off" before the door is opened. These sequences will disable the 'last-out' feature and the step will not extend.

Kwikkee
230 Davidson Avenue
Cottage Grove, OR 97424
(541) 942-3888
www.kwikkeepowergear.com

Troubleshooting

If a problem is discovered during the testing procedure, follow the troubleshooting guide below to determine the source of the problem.

For steps with Control 909510000

Disconnect the motor leads from the control unit. Apply 12 volts to the red wire on the motor only and attach the yellow wire to ground. This will cause the motor to extend the step.

Reverse the polarity to retract the step. Repeat this function 15-20 times. If the step functions properly the motor is fine.

Examine the step frame. Check to see if there is any binding or obstruction impeding the movement of the step.

To thoroughly check the frame you must disconnect the drive linkage from the frame by removing the cotter pin and clevis pin from the end of the linkage. Removing the pins is easier if the step is not fully extended. To stop the step midway out, simply apply enough pressure with your hand to the leading edge of the step to stop its motion. The control will sense the load and stop the step.

Disconnect power to the step either at the battery or by disconnecting the four-way connector between the step control unit and the coach wiring harness. Once the pins have been removed, manually push and pull the step in and out. The frame will need to be free from binding or stiffness in both directions.

If the motor and frame check out, the source of the problem may be in the coach wiring (including the door switch), low voltage, fuses, etc.

If there are any questions, please call **Kwikee Customer Service at 1-800-736-9961.**

B. KwikTest Set Up: For all steps with Control Unit #909510000

Step 4B) Set the Control Switch to "black."

B. Testing Procedures For all steps with Control Unit #909510000

Run the following test a minimum of 6 cycles, allowing 3 to 5 seconds between opening and closing the Door Switch to give the control unit internal relays enough time to reset.

For steps with 909510000 Control												
Perform tests in sequence listed.	Ignition Switch		Override (Power) Switch		Door Switch		Step Function				Step Light	
	OFF	ON	OFF	ON	CLOSED	OPEN	GOES IN	STAYS IN	GOES OUT	STAYS OUT	OFF	ON
Test 1 Settings	■		■		■		✓				✓	
Test 2 Settings	■		■			■			✓			✓
Test 3 Settings	■			■		■				✓		✓
Test 4 Settings	■			■	■					✓	✓	
Test 5 Settings		■		■	■		✓				✓	
Test 6 Settings	■			■	■			✓			✓	
Test 7 Settings	■			■		■			✓			✓

Figure 1: Connecting the KwikTest unit to the Step

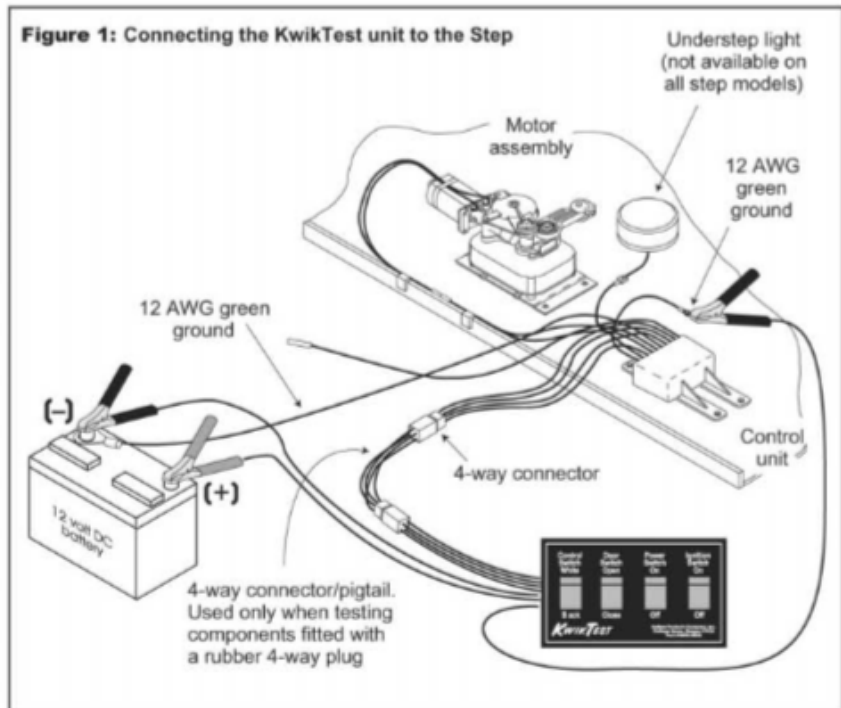

MAINTENANCE: LUBRICATE WITH KWIKLUBE

NOTE: Silicone lubricants and WD-40 are not recommended as they tend to evaporate and dry the mating surfaces, leaving them vulnerable to the elements.

Clean all mud, salt, and road grime from the step before lubricating. With a good quality moisture and heat-resistant penetrating grease, lubricate all moving parts including:

- Bearings
- Clevis pin
- Pivot points
- Drive linkage ball
- Slides

Refer to diagrams below for lubrication points. Please note that diagrams are to be used for general reference only. Some may not pertain to your particular step model.

KwikLube™ Spray Grease is specially formulated to lubricate Kwikkee Electric Steps and is recommended for lubricating all moving parts. KwikLube is a unique aerosol grease with hundreds of automotive, household, and industrial uses in addition to lubricating the steps. It sprays on and into hard to reach places, changing from a penetrating fluid to a tough, protective grease in a matter of minutes. The cured film is impervious to moisture and withstands temperatures above 400°F (204°C). The formula also contains additives to prevent rust and reduce wear.



FIGURE 1

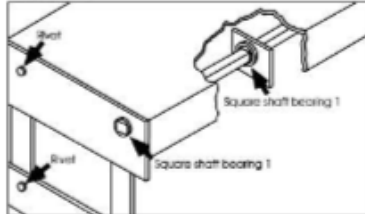

FIGURE 2

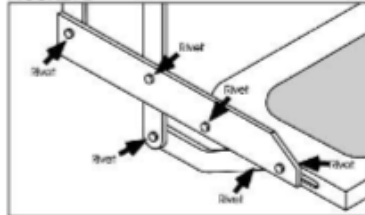

FIGURE 5

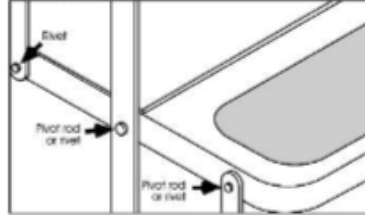

DIAGRAM NOTES:

Fig. 1 & 3: Square shaft bearing: lubricate around outside and under bearing head.
Fig. 4: On step models equipped with plastic cover, this cover will have to be removed to lubricate center bearing. Lubricate bearings under cover every 90 days. Figure 4 also shows bushing-in-bushing lubrication.

Maintain clean, dry electrical connections at the two- and four-way connectors and any butt connectors leading to the vehicle. Apply a small dab of di-electric grease at the connections and replace corroded butt connectors to maintain a good electrical source for the step.

FIGURE 3

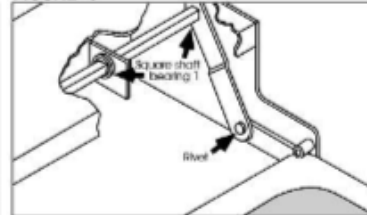

FIGURE 6

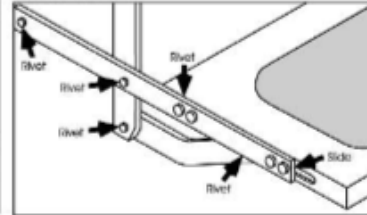

FIGURE 4

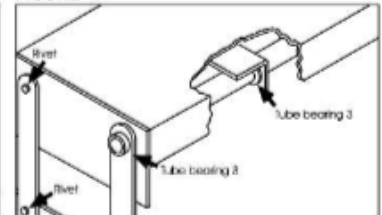
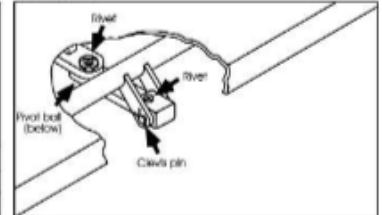

FIGURE 7



A large rectangular area with horizontal blue lines and a vertical red margin line on the left side, resembling a page for writing or a form.

MAINTENANCE: MANUAL RETRACTION OF THE STEP

NOTICE: Before attempting any motor assembly repair work, please read all of the following instructions.

1. To manually retract the step, the step needs to be partially or fully extended to expose the drive linkage. If possible, extend the step with the standard Door Switch operation. If that is not possible, it is necessary to remove the clevis pin.
 2. Unplug the four-way connector from the Control Unit.
 3. Remove the cotter pin from the clevis pin at the linkage assembly.
 4. Remove the clevis pin from the case "U" block in the end of the linkage assembly. Note the direction the clevis pin goes into the cast block. If the step is in its locked position, the pin may have to be pried or driven out of the block.
- Once the clevis pin is removed, the step tread(s) should now swing freely. If they do not, check for a bent step frame or jammed pivot point(s).

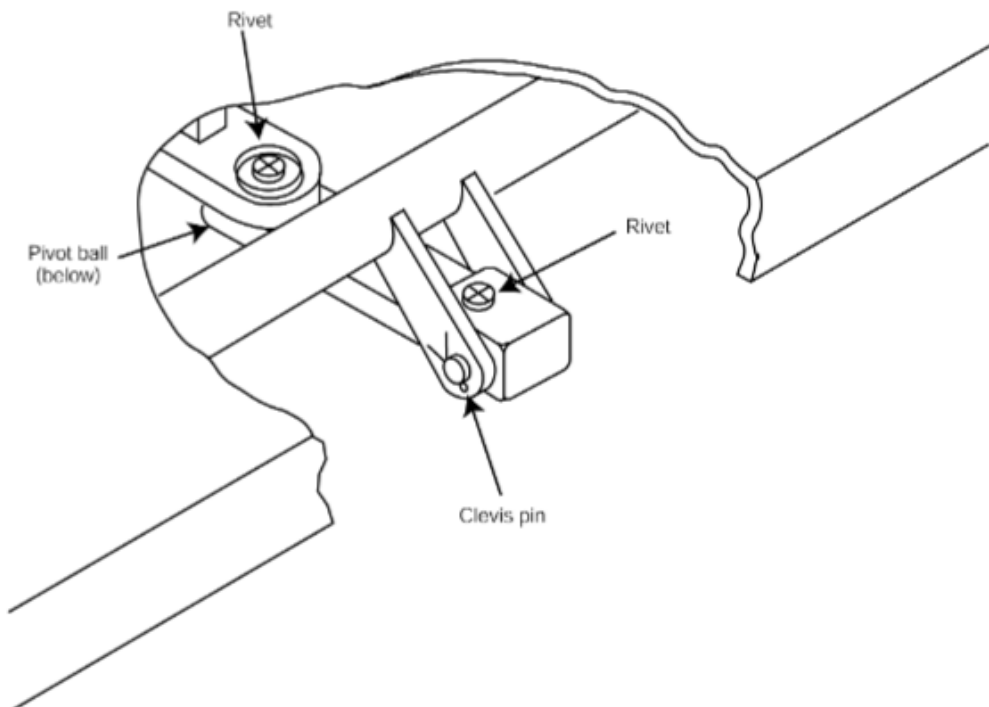









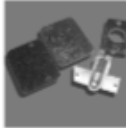

DOOR SWITCHES

When troubleshooting a coach, you may run into any of these door switches. The important thing to determine is whether the switch is "normally open" or "normally closed." Use the chart below to identify the switch.

The current IMGL (integrated motor/gear box/linkage) and 909510000 Control Unit operates properly with any of the belowed listed "NORMALLY OPEN" switches.

Kwikkee Door Switch Replacement Parts Guide

	Magnetic, small rectangular	Magnetic, 3/4" core round	Magnetic, large rectangular	Magnetic, 3/8" core round	Plated plunger switch
White (Normally Closed) Used for all color controls manufactured prior to 2/99. Does NOT include "black" controls #909506000, #909507000					
Part #	905312000	905314000	905306000	905307000	905302000
Black (Normally Open) Used for "black" controls since 2/99 including controls #909506000, #909507000, and #909508000.					
Part #	905323000	905324000	905326000	905327000	905328000



Warranty Policy

Kwikée warrants to the original purchaser that its products are free from defects in material and workmanship from the date of purchase for the periods of time listed in the chart below. See RV manufacturer's warranty for specific details on product warranty for individual applications. Kwikée's obligation under this warranty is limited to the repair or replacement of defective parts returned to Kwikée's factory. See Individual Warranty Procedures for each product.

Kwikée will pay for the labor required to repair or replace its products on claims submitted within the time period listed in the chart below from the date of purchase by original purchaser. See RV manufacturer's warranty for specific details on product warranty for individual applications. The warranty on repaired or replaced parts shall be limited to the unexpired duration of the original warranty.

This warranty does not apply to products or parts that, in Kwikée's opinion, have been subject to abuse, accident, alteration, improper installation/repair, inadequate maintenance or deterioration due to normal wear. Level Best System warranty does not apply to electrical wiring or hydraulic hoses. Cargo slide and utility tray warranty does not apply to base plywood or carpet or other material used to cover base in installation.

Purchaser shall pay all shipping or other transportation charges for any warranty claim.

Kwikée makes no warranty and disclaims any implied warranty, regarding the merchantability, fitness for a particular purpose or the suitability of this product for use with other products. In no event shall Kwikée be liable for incidental, consequential or property damage arising from the purchase and/or use of this product or any claim hereunder. This warranty is in lieu of all other express and implied warranties. Kwikée neither assumes nor authorizes any other person to assume any liability for warranty claims not provided herein.

This warranty gives you specific legal rights including other rights that may vary from state to state. Some states do not allow limitations on implied warranties and exclusion or limitation of incidental or consequential damages, therefore the limitations and exclusions contained herein may not apply to you.

Any questions regarding warranty claims should be directed to your dealer or contact: Kwikée Customer Service Representative, 230 Davidson Ave., Cottage Grove, Oregon 97424. Contact Kwikée Customer Service by telephone at 1-800-736-9961.

PRODUCT	WARRANTY PERIODS*		
	PARTS	LABOR	OTHER
Electric and Manual Steps	Two (2) years	Two (2) years	One (1) year on finish
Level Best® Leveling/Stabilizing System	Five (5) years	Two (2) years	
DigiSync® Room Slide	One (1) years	One (1) year	
Cargo Slides	One (1) years	One (1) year	
Utility Trays	One (1) years	One (1) year	

* Warranty periods may vary. See manufacturer of RV warranty information for details.

NOTE: Any parts returned for warranty service/repair with wires cut will result in voiding of the warranty. It is important to read and understand all product documentation thoroughly before initiating any installation. Kwikée assumes no liability for damages or injury resulting from the improper installation or operation.



Kwikée Products Company, Inc.
 230 Davidson Avenue
 Cottage Grove, Oregon 97424-9545
 (541) 942-3888 FAX (541) 942-5515



Effective July 1, 2003
Please note changes
from 4/1/02 procedures

Electric
Steps

Warranty Procedures

This advisory is intended to explain warranty procedures with regard to Kwikkee Automatic Electric Steps. Observing proper warranty procedures will expedite the processing of warranty claims and reduce the number of claims that are denied. Please take note of the following advice to avoid the denial of warranty or a reduction in the reimbursement to your warranty claim.

- Do not replace entire assemblies** when repairing a step under warranty. Replace only those parts that are actually defective. Motors, gear cases, gears, linkage assemblies, and control units are all replaceable as individual parts.

If you exchange a complete assembly when only the replacement of an individual part is required, the non-defective parts will be returned and only the defective part will be credited to you.
Example: If a linkage assembly breaks and the entire motor assembly is replaced to repair the step, the motor, gear case, and gears will be returned to you, and only the linkage assembly will be credited to you. Meanwhile, you bought and paid for an **entire** motor assembly that you did not need.
- Do not use conversion kits for warranty repairs.** Conversion kits are intended for the conversion of older, out-of-warranty steps with field-wound motors to the newer permanent magnet motor system. If an entire conversion kit is used to repair a step under warranty, labor will only be credited for repair time associated with the defective part. **The purchase of conversion kits for warranty work will only cost you money.**
- An RMA (Returned Materials Authorization) number must be obtained before any parts or claims are sent in.** Call Kwikkee's Service Line at 1 (800) 736-9961 for an RMA number. Claims or parts sent in without this number attached will not be processed, risk the chance of being lost, and will only delay the processing of your claim.
- Unless prior authorization is given by Kwikkee, reimbursement of labor claims will be limited to the periods of time authorized as listed in the table below.**

DEFECTIVE PART	DIAGNOSTIC TIME	REPAIR TIME	TOTAL TIME
Control Unit Only	0.3 hours	0.3 hours	0.6 hours
Motor	0.2 hours	0.4 hours	0.6 hours
Linkage	0	0.3 hours	0.3 hours
Gear/Gear Case	0.3 hours	0.5 hours	0.8 hours
Door Switch	0.3 hours	0.2 hours	0.5 hours
Frame Only	0.2 hours	0.8 hours	1.0 hours

- Our warranty does not cover travel time, mileage, or other incidental costs.** It is limited solely to the replacement of defective parts under warranty and the flat rate labor schedule listed above.
- Do not cut any wires on control units or motors.** Cut wires will automatically void the warranty as Kwikkee will have no way of testing or verifying your claim.

Do not deviate from any of the guidelines listed above. For questions regarding these warranty procedures, technical assistance, call 1-800-736-9961. Shipping charges for returning parts to Kwikkee shall be the responsibility of the customer. Kwikkee will pay shipping charges when returning warrantable goods to the customer. Kwikkee will not accept C.O.D. shipments of any returned goods.



Kwikkee Products Company, Inc.
230 Davidson Avenue
Cottage Grove, Oregon 97424-9545
(541) 942-3888 FAX (541) 942-5515

NOTICE: All claims must be processed within 45 days of RMA issuance. Claims received after 45 days will forfeit any reimbursement entitlement.